

# DATA SHEET

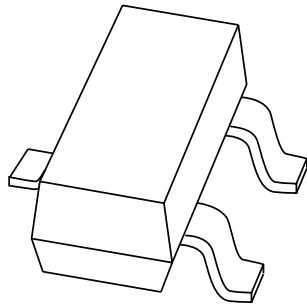

## **MMBT3904** NPN switching transistor

Product specification  
Supersedes data of 2002 Oct 04

2004 Feb 03

# NPN switching transistor

# MMBT3904

### FEATURES

- Collector current capability  $I_C = 200 \text{ mA}$
- Collector-emitter voltage  $V_{CEO} = 40 \text{ V}$ .

### APPLICATIONS

- General switching and amplification.

### DESCRIPTION

NPN switching transistor in a SOT23 plastic package.  
PNP complement: MMBT3906.

### MARKING

TYPE NUMBER	MARKING CODE <sup>(1)</sup>
MMBT3904	7A*

### Note

- \* = p: Made in Hong Kong.  
\* = t: Made in Malaysia.  
\* = W: Made in China.

### QUICK REFERENCE DATA

SYMBOL	PARAMETER	MAX.	UNIT
$V_{CEO}$	collector-emitter voltage	40	V
$I_C$	collector current (DC)	200	mA

### PINNING

PIN	DESCRIPTION
1	base
2	emitter
3	collector

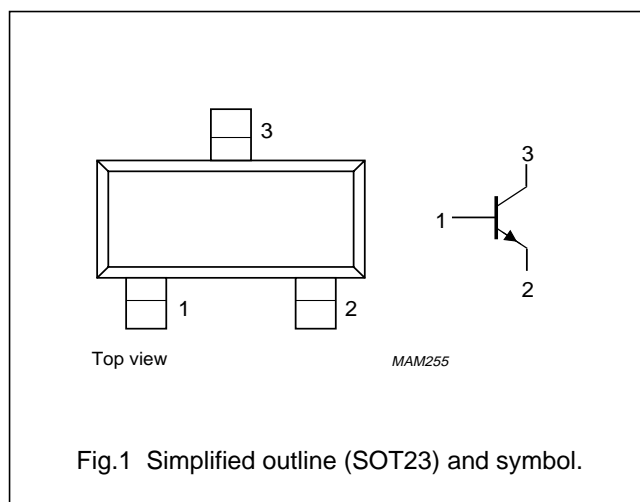

### ORDERING INFORMATION

TYPE NUMBER	PACKAGE		
	NAME	DESCRIPTION	VERSION
MMBT3904	–	plastic surface mounted package; 3 leads	SOT23

## NPN switching transistor

MMBT3904

**LIMITING VALUES**

In accordance with the Absolute Maximum Rating System (IEC 60134).

SYMBOL	PARAMETER	CONDITIONS	MIN.	MAX.	UNIT
$V_{CBO}$	collector-base voltage	open emitter	–	60	V
$V_{CEO}$	collector-emitter voltage	open base	–	40	V
$V_{EBO}$	emitter-base voltage	open collector	–	6	V
$I_C$	collector current (DC)		–	200	mA
$I_{CM}$	peak collector current		–	200	mA
$I_{BM}$	peak base current		–	100	mA
$P_{tot}$	total power dissipation	$T_{amb} \leq 25\text{ °C}$ ; note 1	–	250	mW
$T_{stg}$	storage temperature		–65	+150	°C
$T_j$	junction temperature		–	150	°C
$T_{amb}$	operating ambient temperature		–65	+150	°C

**Note**

1. Transistor mounted on an FR4 printed-circuit board.

**THERMAL CHARACTERISTICS**

SYMBOL	PARAMETER	CONDITIONS	VALUE	UNIT
$R_{th(j-a)}$	thermal resistance from junction to ambient	note 1	500	K/W

**Note**

1. Transistor mounted on an FR4 printed-circuit board.

## NPN switching transistor

## MMBT3904

## CHARACTERISTICS

$T_{amb} = 25\text{ }^{\circ}\text{C}$  unless otherwise specified.

SYMBOL	PARAMETER	CONDITIONS	MIN.	MAX.	UNIT
$I_{CBO}$	collector cut-off current	$I_E = 0; V_{CB} = 30\text{ V}$	–	50	nA
$I_{EBO}$	emitter cut-off current	$I_C = 0; V_{EB} = 6\text{ V}$	–	50	nA
$h_{FE}$	DC current gain	$V_{CE} = 1\text{ V}$ ; see Fig.2; note 1 $I_C = 0.1\text{ mA}$ $I_C = 1\text{ mA}$ $I_C = 10\text{ mA}$ $I_C = 50\text{ mA}$ $I_C = 100\text{ mA}$	60 80 100 60 30	– – 300 – –	
$V_{CEsat}$	collector-emitter saturation voltage	$I_C = 10\text{ mA}; I_B = 1\text{ mA}$	–	200	mV
		$I_C = 50\text{ mA}; I_B = 5\text{ mA}$	–	300	mV
$V_{BEsat}$	base-emitter saturation voltage	$I_C = 10\text{ mA}; I_B = 1\text{ mA}$	650	850	mV
		$I_C = 50\text{ mA}; I_B = 5\text{ mA}$	–	950	mV
$C_c$	collector capacitance	$I_E = I_e = 0; V_{CB} = 5\text{ V}; f = 1\text{ MHz}$	–	4	pF
$C_e$	emitter capacitance	$I_C = I_c = 0; V_{BE} = 500\text{ mV}; f = 1\text{ MHz}$	–	8	pF
$f_T$	transition frequency	$I_C = 10\text{ mA}; V_{CE} = 20\text{ V}; f = 100\text{ MHz}$	300	–	MHz
F	noise figure	$I_C = 100\text{ }\mu\text{A}; V_{CE} = 5\text{ V}; R_S = 1\text{ k}\Omega; f = 10\text{ Hz to }15.7\text{ kHz}$	–	5	dB
<b>Switching times (between 10% and 90% levels); see Fig.3</b>					
$t_d$	delay time	$I_{Con} = 10\text{ mA}; I_{Bon} = 1\text{ mA}; I_{Boff} = -1\text{ mA}$	–	35	ns
$t_r$	rise time		–	35	ns
$t_s$	storage time		–	200	ns
$t_f$	fall time		–	50	ns

## Note

1. Pulse test:  $t_p \leq 300\text{ }\mu\text{s}; \delta \leq 0.02$ .

NPN switching transistor

MMBT3904

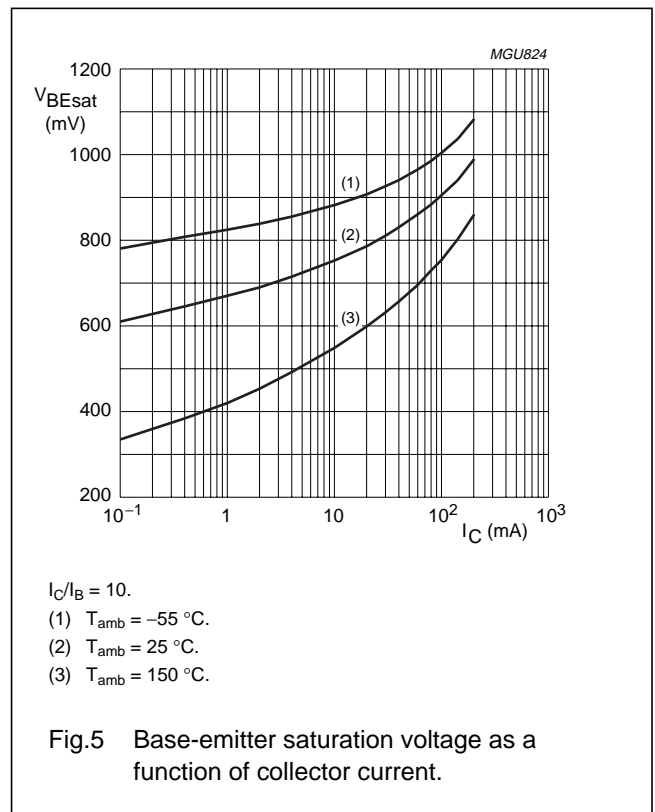
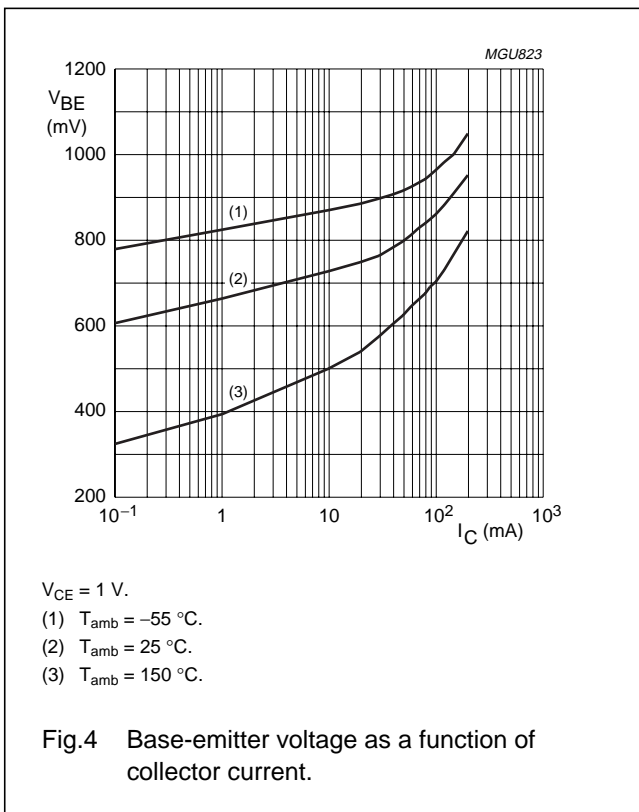
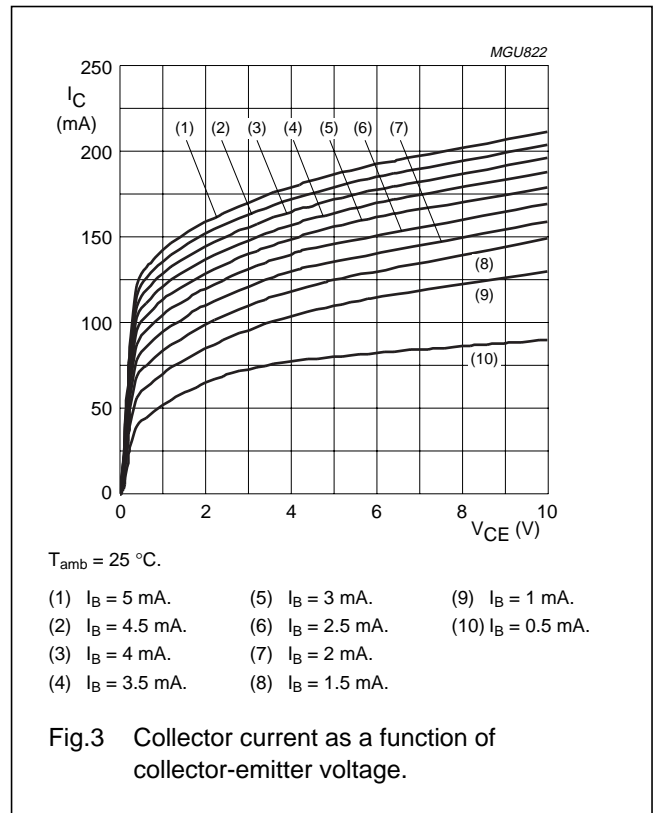
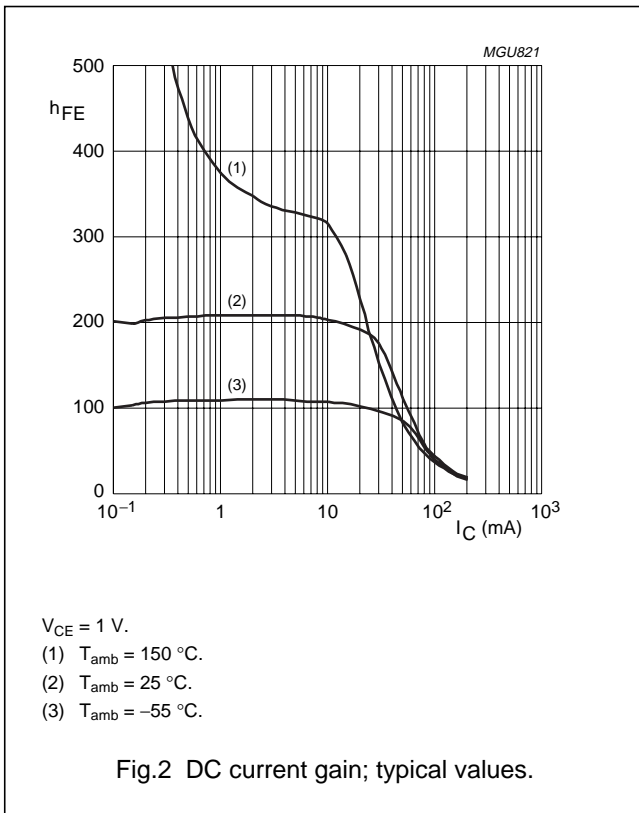

NPN switching transistor

MMBT3904

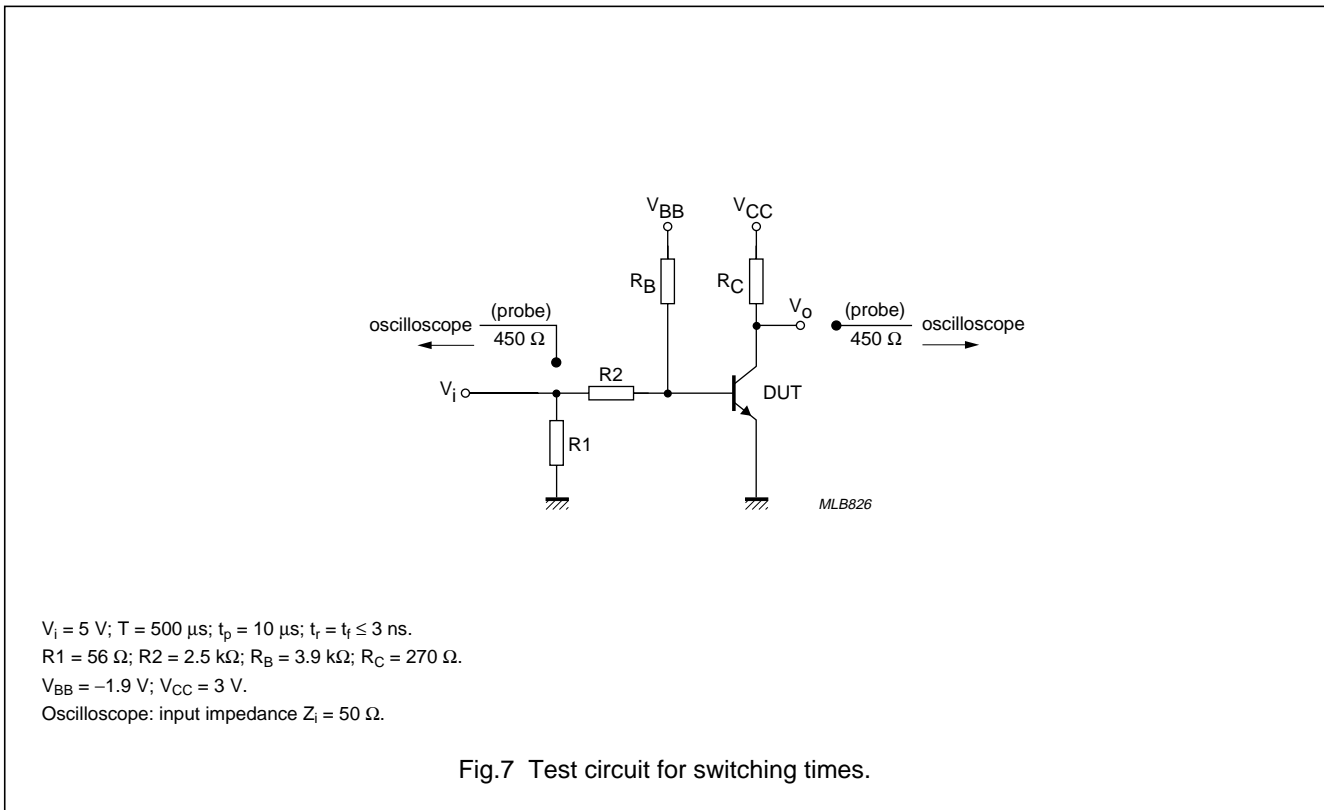
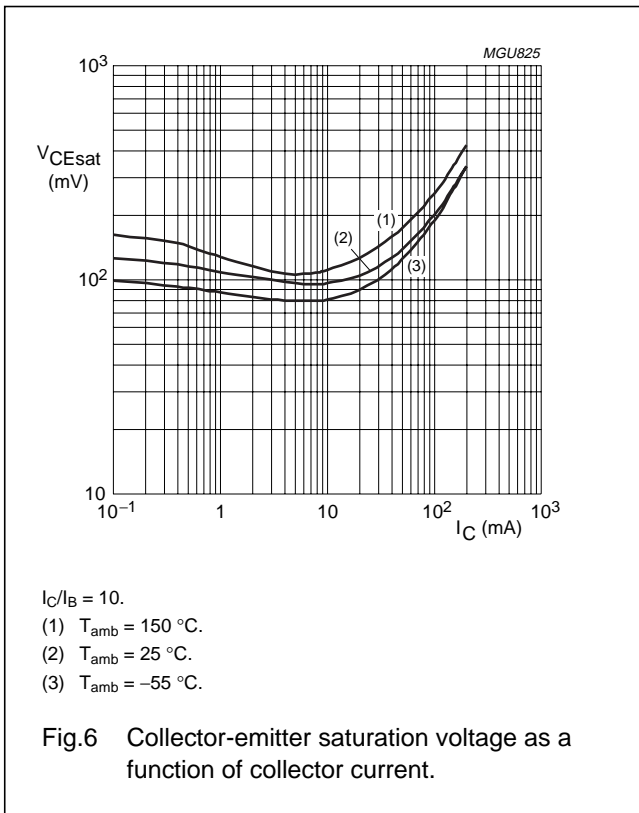

NPN switching transistor

MMBT3904

PACKAGE OUTLINE

Plastic surface mounted package; 3 leads

SOT23

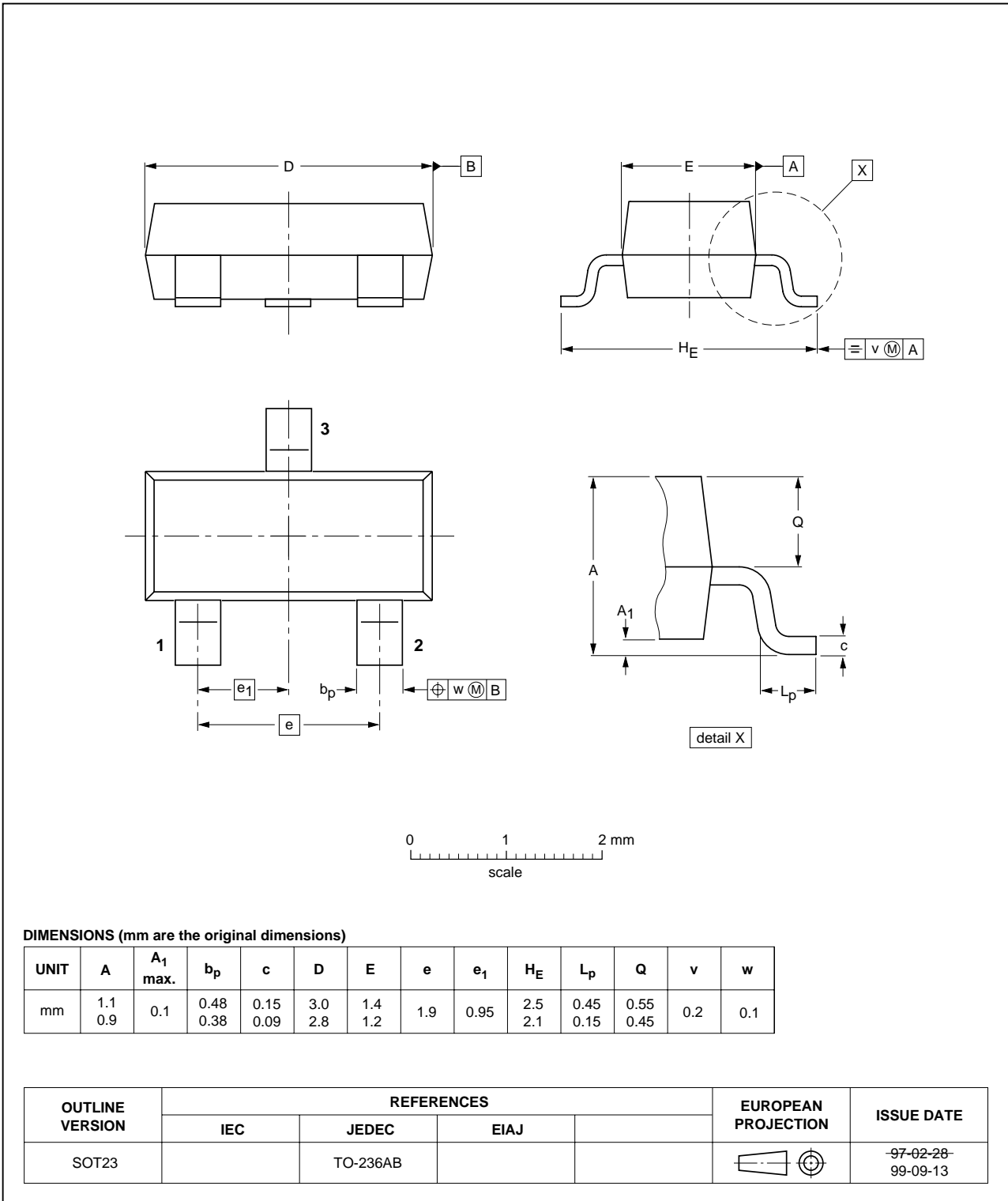

## NPN switching transistor

MMBT3904

## DATA SHEET STATUS

LEVEL	DATA SHEET STATUS <sup>(1)</sup>	PRODUCT STATUS <sup>(2)(3)</sup>	DEFINITION
I	Objective data	Development	This data sheet contains data from the objective specification for product development. Philips Semiconductors reserves the right to change the specification in any manner without notice.
II	Preliminary data	Qualification	This data sheet contains data from the preliminary specification. Supplementary data will be published at a later date. Philips Semiconductors reserves the right to change the specification without notice, in order to improve the design and supply the best possible product.
III	Product data	Production	This data sheet contains data from the product specification. Philips Semiconductors reserves the right to make changes at any time in order to improve the design, manufacturing and supply. Relevant changes will be communicated via a Customer Product/Process Change Notification (CPCN).

## Notes

1. Please consult the most recently issued data sheet before initiating or completing a design.
2. The product status of the device(s) described in this data sheet may have changed since this data sheet was published. The latest information is available on the Internet at URL <http://www.semiconductors.philips.com>.
3. For data sheets describing multiple type numbers, the highest-level product status determines the data sheet status.

## DEFINITIONS

**Short-form specification** — The data in a short-form specification is extracted from a full data sheet with the same type number and title. For detailed information see the relevant data sheet or data handbook.

**Limiting values definition** — Limiting values given are in accordance with the Absolute Maximum Rating System (IEC 60134). Stress above one or more of the limiting values may cause permanent damage to the device. These are stress ratings only and operation of the device at these or at any other conditions above those given in the Characteristics sections of the specification is not implied. Exposure to limiting values for extended periods may affect device reliability.

**Application information** — Applications that are described herein for any of these products are for illustrative purposes only. Philips Semiconductors make no representation or warranty that such applications will be suitable for the specified use without further testing or modification.

## DISCLAIMERS

**Life support applications** — These products are not designed for use in life support appliances, devices, or systems where malfunction of these products can reasonably be expected to result in personal injury. Philips Semiconductors customers using or selling these products for use in such applications do so at their own risk and agree to fully indemnify Philips Semiconductors for any damages resulting from such application.

**Right to make changes** — Philips Semiconductors reserves the right to make changes in the products - including circuits, standard cells, and/or software - described or contained herein in order to improve design and/or performance. When the product is in full production (status 'Production'), relevant changes will be communicated via a Customer Product/Process Change Notification (CPCN). Philips Semiconductors assumes no responsibility or liability for the use of any of these products, conveys no licence or title under any patent, copyright, or mask work right to these products, and makes no representations or warranties that these products are free from patent, copyright, or mask work right infringement, unless otherwise specified.



# ***Philips Semiconductors – a worldwide company***

## **Contact information**

For additional information please visit <http://www.semiconductors.philips.com>. Fax: +31 40 27 24825

For sales offices addresses send e-mail to: [sales.addresses@www.semiconductors.philips.com](mailto:sales.addresses@www.semiconductors.philips.com).

© Koninklijke Philips Electronics N.V. 2004

SCA76

All rights are reserved. Reproduction in whole or in part is prohibited without the prior written consent of the copyright owner.

The information presented in this document does not form part of any quotation or contract, is believed to be accurate and reliable and may be changed without notice. No liability will be accepted by the publisher for any consequence of its use. Publication thereof does not convey nor imply any license under patent- or other industrial or intellectual property rights.

Printed in The Netherlands

R75/04/pp9

Date of release: 2004 Feb 03

Document order number: 9397 750 12624

*Let's make things better.*

**Philips  
Semiconductors**



**PHILIPS**