

REV.	DESCRIPTION	DATE
A	NEW DRAWING	12/2/2005

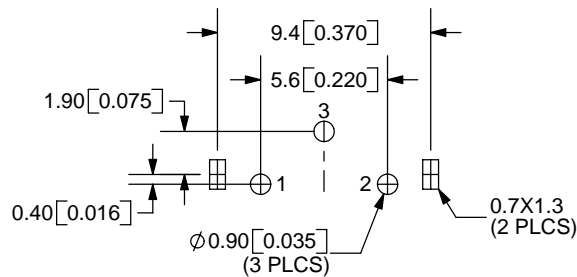
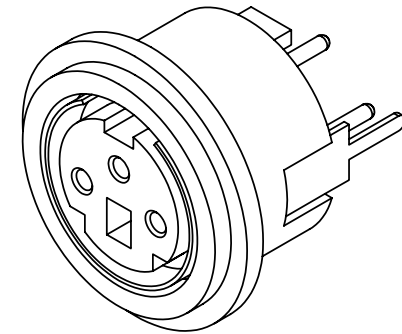
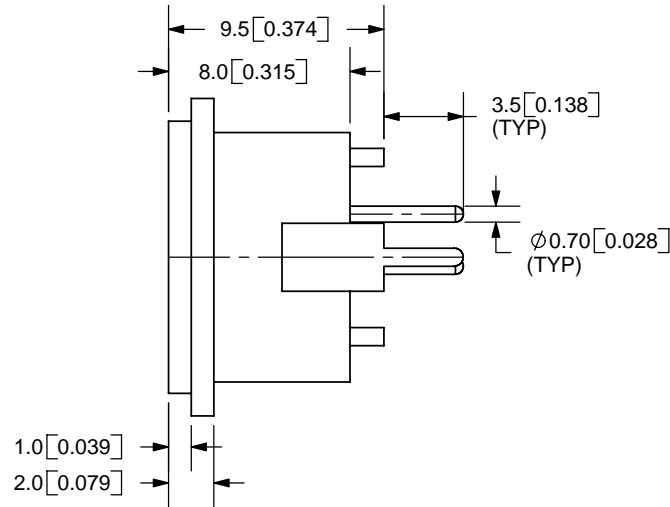
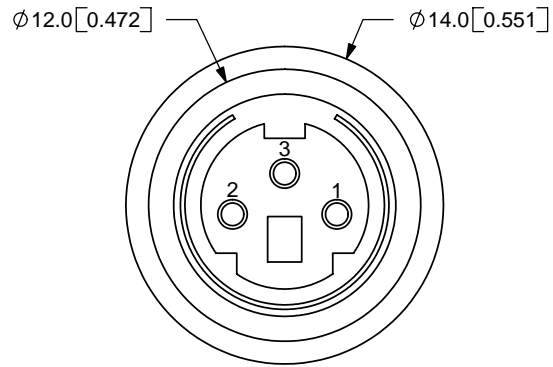

PCB LAYOUT
BACK VIEW

SPECIFICATIONS:

RATING: 12V DC @ 2A; 100V AC @ 1A
 INSULATION RESISTANCE: 50M OHMS MIN; 250V DC
 VOLTAGE WITHSTAND: 250V AC R.M.S. FOR 1 MINUTE
 CONTACT RESISTANCE: 30m OHMS MAX
 INSERTION FORCE: 4.5KG MAX
 WITHDRAWAL FORCE: 0.8KG~3KG
 LIFE: 5,000 CYCLES



TOLERANCE:
±0.2mm



20050 SW 112th Ave.
 Tualatin, OR 97062
 Phone: 503-643-4899
 800-275-4899
 Fax: 503-372-1266
 Website: www.cui.com

	MATERIAL	PLATING
TERMINALS (1-3)	Phosphor Bronze	Silver
EARTH TERMINAL	Brass	Tin
HOUSING	PBT	

TITLE: MINI CIRCULAR CON.-VERTICAL MOUNT		REV: A
PART NO. MD-30SV	UNITS: MM [INCHES]	
DRAWN BY: ZRJ	APPROVED BY:	SCALE: 3:1

PC FILE NAME:
MD-30SV

COPYRIGHT 2006 BY CUI INC.