

Distinctive Characteristics

Extremely low profile of 5mm from PCB to top of switch.

Rubber seal construction prevents contact contamination and allows automated soldering and cleaning.

Minimal operating force and short stroke permit light touch operation.

Dome contact gives crisp tactile and audible feedback to positively indicate circuit transfer and assures high reliability and long life.

Wide choice of body shapes and colors.

Crimped terminals provide a spring type action to ensure secure mounting and prevent dislodging during wave soldering.

Space saving body dimensions provide for compact, side-by-side mounting on a standard grid.

Terminal spacing conforms to standard .100" (2.54mm) PCB grid.

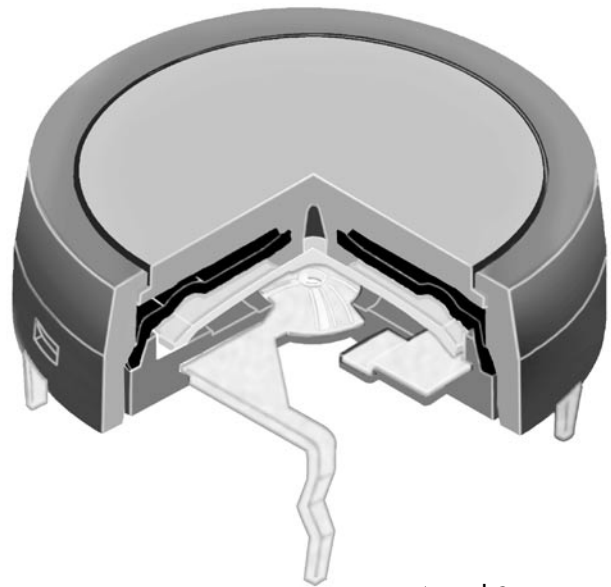

Actual Size



KEYBOARD MATRIX

Common Bus Matrix

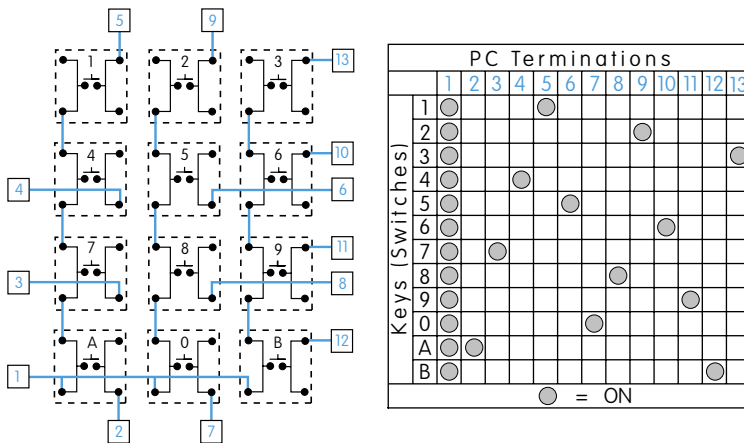

Blue = PCB Trace, Black = Switch Circuit

These single pole, single throw switches can be used in a keyboard matrix, and, using strapped terminals, achieve a common bus electrical configuration on a single-sided PC board.

X-Y Matrix

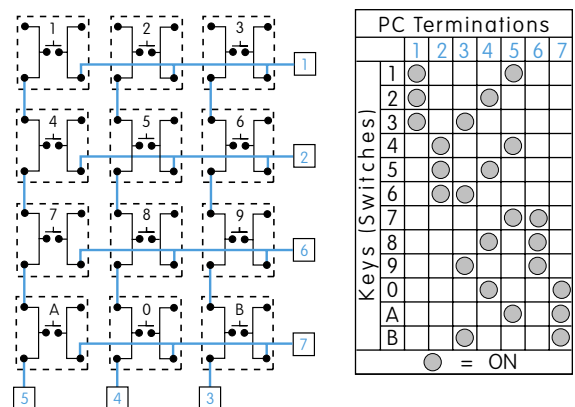

Blue = PCB Trace, Black = Switch Circuit

These single pole, single throw switches can be arranged on a single-sided PC board matrix with strapped terminals to achieve an X-Y type electrical interconnection.

General Specifications

Electrical Capacity (Resistive Load)

Low Level: 50mA @ 24V DC

Other Ratings

Contact Resistance: 50 milliohms maximum
Insulation Resistance: 500 megohms minimum @ 250V DC
Dielectric Strength: 250V AC minimum for 1 minute minimum
Mechanical Life: 500,000 operations minimum
Electrical Life: 500,000 operations minimum
Nominal Operating Force: 1.96N for sculptured actuator
 2.0N for piano actuator
 3.0N for square & round flush actuators
Total Travel: Flush Actuators .016" (0.4mm)
 Sculptured & Piano Actuators .031" (0.8mm)

Materials & Finishes

Actuator: Polyamide
Case: Glass fiber reinforced polyamide
Seal: Nitrile butadiene rubber
Base: Glass fiber reinforced polyester
Movable Contact: Phosphor bronze with silver plating
Stationary Contacts: Brass with silver plating
Terminals: Brass with silver plating

Environmental Data

Operating Temperature Range: -25°C through +85°C (-13°F through +185°F)
Humidity: 90 ~ 95% humidity for 96 hours @ 40°C (104°F)
Vibration: 10 ~ 55Hz with peak-to-peak amplitude of 1.5mm traversing the frequency range & returning in 1 minute; 3 right angled directions for 2 hours
Shock: 50G (490m/s²) acceleration (tested in 6 right angled directions, with 5 shocks in each direction)

PCB Processing

Soldering: Wave Soldering Recommended. See Profile A in Supplement section.
 Manual Soldering: See Profile A in Supplement section.
Cleaning: Automated cleaning. See Cleaning specifications in Supplement section.

Standards & Certifications

UL Recognition or CSA Certification: The JF Series tactiles have not been tested for UL recognition or CSA certification. These switches are designed for use in a low-voltage, low-current, logic-level circuit. When used as intended in a logic-level circuit, the results do not produce hazardous energy.

TYPICAL SWITCH ORDERING EXAMPLE

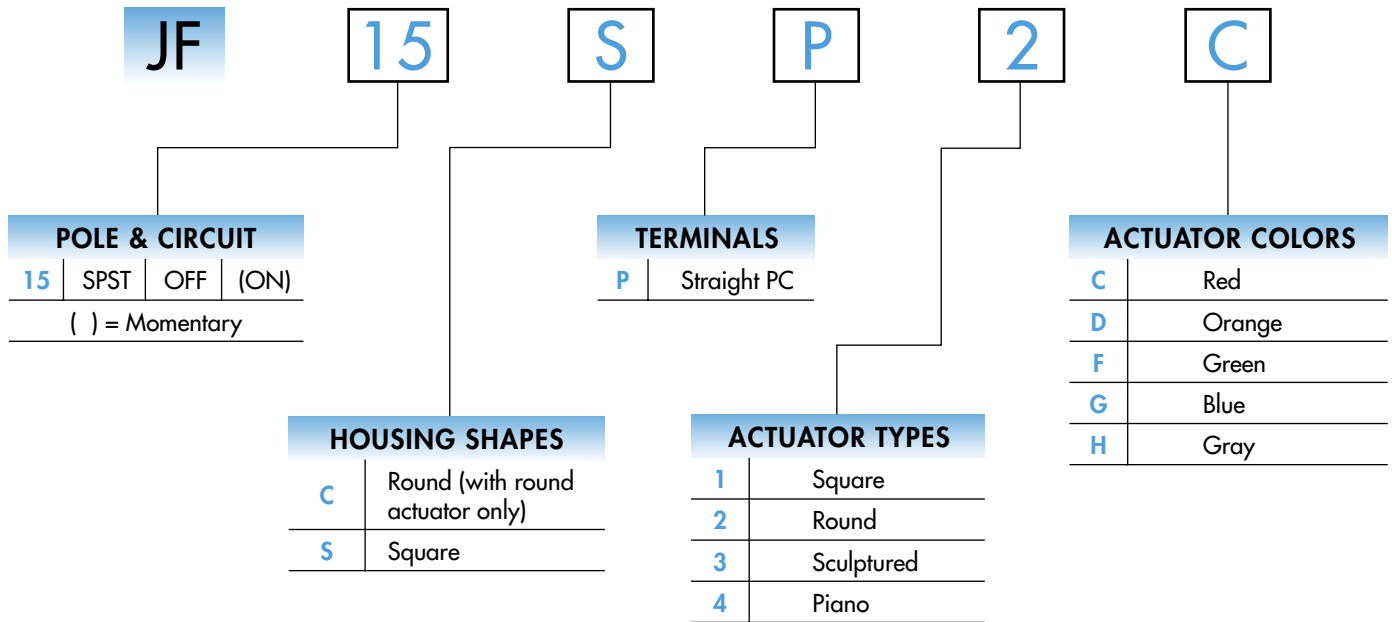

DESCRIPTION FOR TYPICAL ORDERING EXAMPLE

JF15SP2C

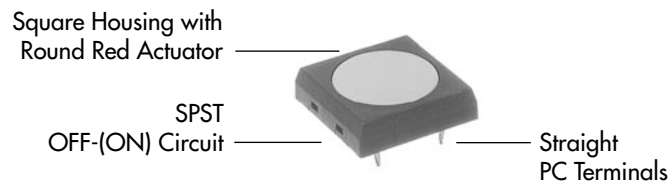

POLE & CIRCUIT

Pole	Model	Actuator Position () = Momentary		Switch Throw & Schematic	Note: Terminal numbers are shown on the switch.
		Normal	Down		
SP	JF15	OFF	(ON)	SPST	

HOUSING SHAPES & ACTUATOR TYPES

C Round Housing

S Square Housing

2 Round Actuator



1 Square Actuator

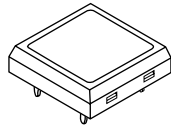

2 Round Actuator

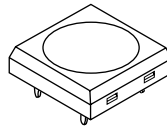

3 Sculptured Actuator

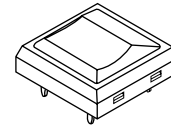

4 Piano Actuator



Actuator Colors Available:

C Red

D Orange

F Green

G Blue

H Gray

Housing is Black

TERMINALS & PANEL DESIGN

P Straight PC

Additional details in Typical Switch Dimensions

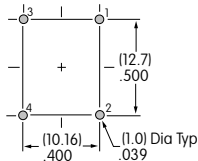
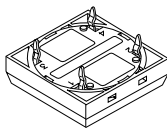

Versatile panel arrangements can be made to fit individual design needs.

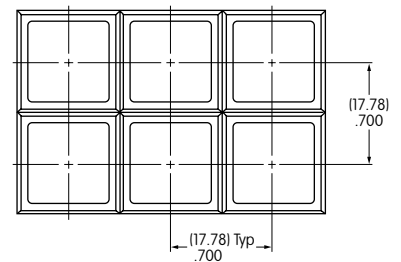
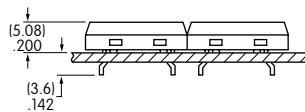

TYPICAL SWITCH DIMENSIONS

Round Actuator

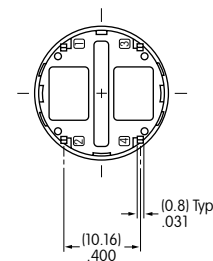
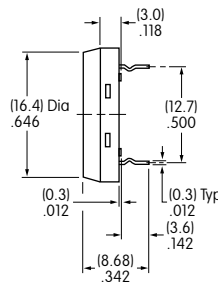
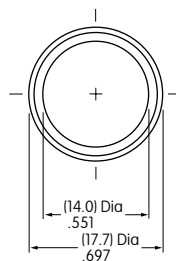

JF15CP2C

TYPICAL SWITCH DIMENSIONS

Square Actuator

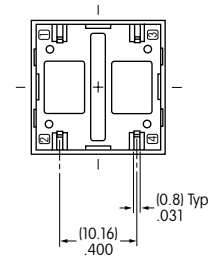
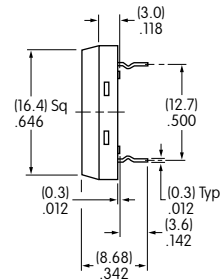
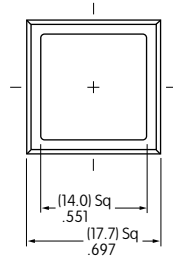

JF15SP1C

Round Actuator

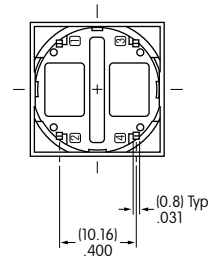
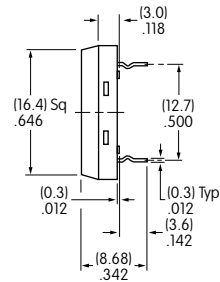
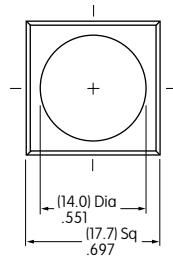

JF15SP2C

Sculptured Actuator

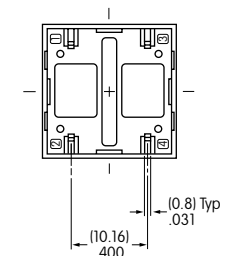
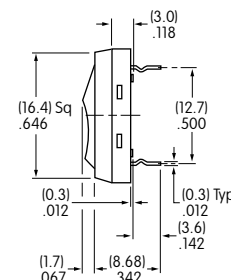
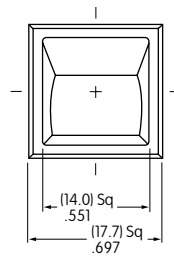

JF15SP3C

Piano Actuator

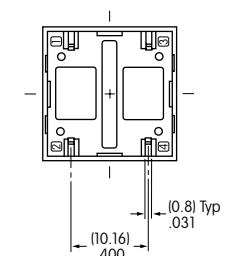
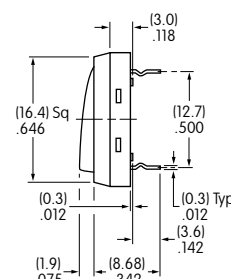
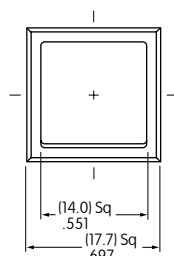
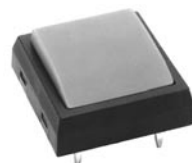

JF15SP4C

LEGENDS

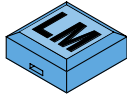

Easily create and submit your own legends using our new on-line Legend Maker.

Visit www.nkkswitches.com

For other legend support options, customers may either contact the factory and request the JF Legend Packet, or utilize the general information and basic specifications presented below.

Shaded Areas are Printable Areas

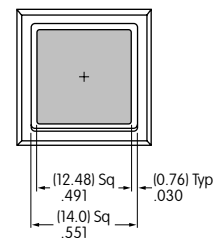
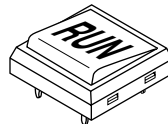
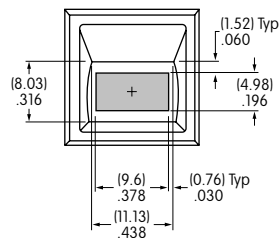
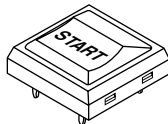
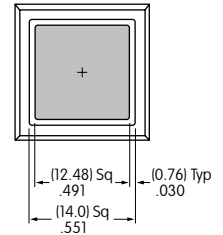
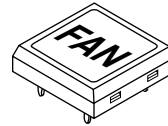
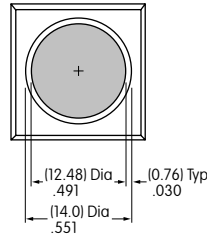
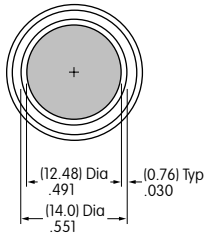

Recommended Print Methods: Screen Print or Pad Print. Epoxy based ink is recommended.

Additional Method

Engraving is not recommended as an additional method for legends. Contact factory if engraving is required; it must be done before the actuator is assembled.