

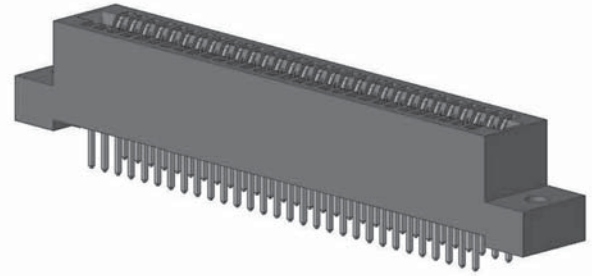

**.100" [2.54mm] Contact Centers, .610" Insulator Height, Dip Solder/Wire Wrap/
Right Angle/Card Extender for .093" [2.36] or .125" [3.18] Mating PCB**

SPECIFICATIONS

- Accommodates .093" ± .008" [2.36 ± .20] or .125" ± .008" [3.18 ± .20] mating PC board (Consult factory for .031" ± .008" [.79 ± .20] boards)
- PBT, PPS or PA9T insulator
- Molded-in key available
- 3 amp current rating per contact
- 30 milli ohm maximum at rated current



Sullins Edgecards

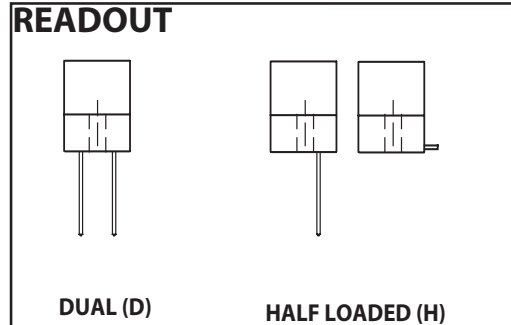

TERMINATION TYPE

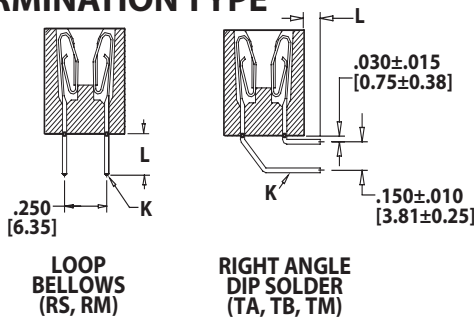

TERMINATION TYPE		POST CROSS SECTION (K)	POST LENGTH L ±.025 [.64]	FITS MIN. HOLE SIZE
RS	Dip Solder	.025 [.64] SQUARE	.190 [4.83]	.040 [1.02]
RM	Wire Wrap	.025 [.64] SQUARE	.560 [14.20]	.040 [1.02]
TA	Right Angle	.025 [.64] SQUARE	.100 [2.54]	.043 [1.09]
TB	Right Angle	.025 [.64] SQUARE	.180 [4.57]	.043 [1.09]
TM	Right Angle	.025 [.64] SQUARE	.250 [6.35]	.043 [1.09]

PCB LAYOUT

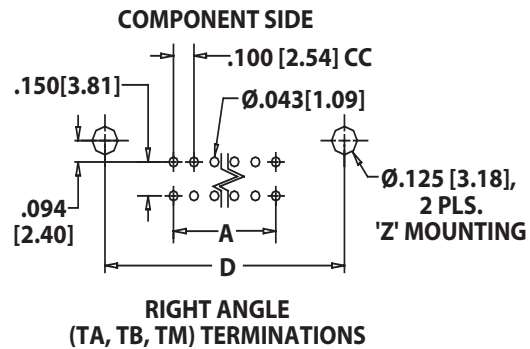
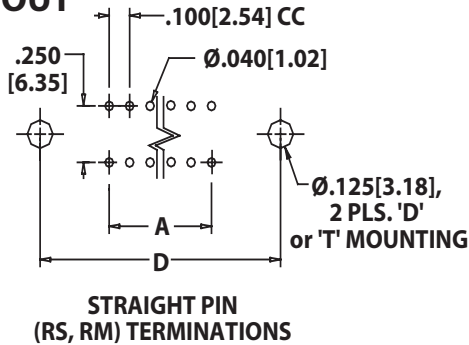

MOUNTING STYLE

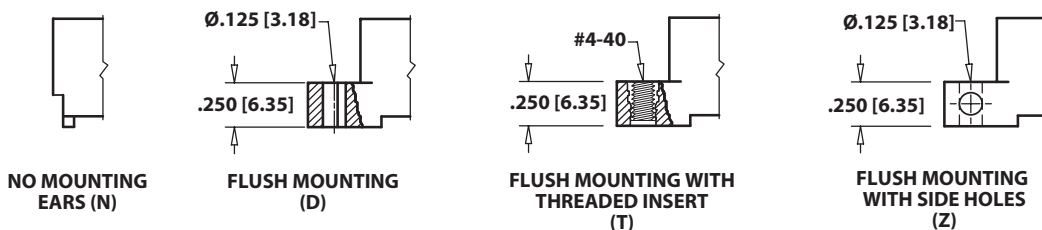



**.100" [2.54mm] Contact Centers, .610" Insulator Height, Dip Solder/Wire Wrap/
Right Angle/Card Extender for .093"[2.36] or .125"[3.18] Mating PCB**

PART NUMBER CODING

MATERIALS (Insulator /Contact)

- E = PBT/Phosphor Bronze
- R = PPS/Phosphor Bronze
- G = PA9T/Phosphor Bronze
- H = PBT/Beryllium Copper
- A = PPS/Beryllium Copper
- J = PA9T/Beryllium Copper
- (Consult Factory for Other Materials)

CONTACT FINISH - RoHS Compliant

All platings are Lead Free and have .000050" Nickel underplate

	Contact Surface	Termination
B =	.00010" Gold	.000100" Pure Tin, Matte
C =	.000030" Gold	.000100" Pure Tin, Matte
G =	.000010" Gold	.000005" Gold
Y =	.000030" Gold	.000005" Gold
	Contact Surface	Overall Plating
S =	.00010" Gold	.000010" Gold
M =	.000030" Gold	.000010" Gold
E =	.000100" Pure Tin, Matte	.000100" Pure Tin, Matte

E B C 70 D RM D - S273

MODIFICATION CODE (Consult Factory)

- S273 = FOR .093" ± .008" [2.36 ± .20] THICK MATING PCB
- S664 = FOR .125" ± .008" [3.18 ± .20] THICK MATING PCB

MOUNTING STYLE (Opposite Page)

- N = No Mounting
- D = Flush Mounting
- T = Flush Mounting With Threaded Inserts
- Z = Flush Mounting With Side Holes

TERMINATION TYPE (Opposite Page)

- RS = .025" [0.64mm] Square Dip Solder
- RM = .025" [0.64mm] Square Wire Wrap
- TA, TB, TM = .025" [0.64mm] Square Right Angle

READOUT (Opposite Page)

- D = Dual
- H = Half Loaded

NUMBER OF CONTACT POSITIONS

See Chart Below

CONTACT CENTERS

C = .100" [2.54mm]

DIMENSIONS Dimensions in [] are in millimeters, all others are in inches.

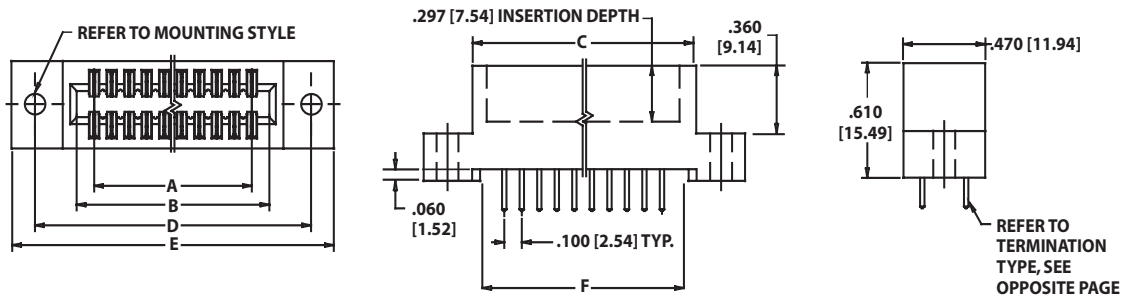

Tolerances with PPS Insulator Material may vary slightly due to shrinkage differential; Consult Factory.

POSITIONS/ CONTACTS	INCHES						[MILLIMETERS]					
	A±.008	B±.008	C±.015	D±.010	E±.020	F±.015	A±0.20	B±0.20	C±0.38	D±0.25	E±0.51	F±0.38
06/12	0.500	0.700	0.860	1.175	1.435	0.750	12.70	17.78	21.84	29.85	36.45	19.05
07/14*	0.600	0.800	0.960	1.275	1.535	0.850	15.24	20.32	24.38	32.39	38.99	21.59
08/16*	0.700	0.900	1.060	1.375	1.635	0.950	17.78	22.86	26.92	34.93	41.53	24.13
10/20	0.900	1.100	1.260	1.575	1.835	1.150	22.86	27.94	32.00	40.01	46.61	29.21
12/24	1.100	1.300	1.460	1.775	2.035	1.350	27.94	33.02	37.08	45.09	51.69	34.29
15/30*	1.400	1.600	1.760	2.075	2.335	1.650	35.56	40.64	44.70	52.71	59.31	41.91
17/34*	1.600	1.800	1.960	2.275	2.535	1.850	40.64	45.72	49.78	57.79	64.39	46.99
18/36	1.700	1.900	2.060	2.375	2.635	1.950	43.18	48.26	52.32	60.33	66.93	49.53
20/40*	1.900	2.100	2.260	2.575	2.835	2.150	48.26	53.34	57.40	65.41	72.01	54.61
22/44	2.100	2.300	2.460	2.775	3.035	2.350	53.34	58.42	62.48	70.49	77.09	59.69
24/48*	2.300	2.500	2.660	2.975	3.235	2.550	58.42	63.50	67.56	75.57	82.17	64.77
25/50*	2.400	2.600	2.760	3.075	3.335	2.650	60.96	66.04	70.10	78.11	84.71	67.31
28/56*	2.700	2.900	3.060	3.375	3.635	2.950	68.58	73.66	77.72	85.73	92.33	74.93
30/60	2.900	3.100	3.260	3.575	3.835	3.150	73.66	78.74	82.80	90.81	97.41	80.01
31/62*	3.000	3.200	3.360	3.675	3.935	3.250	76.20	81.28	85.34	93.35	99.95	82.55
35/70	3.400	3.600	3.760	4.075	4.335	3.650	86.36	91.44	95.50	103.51	110.11	92.71
36/72	3.500	3.700	3.860	4.175	4.435	3.750	88.90	93.98	98.04	106.05	112.65	95.25
40/80*	3.900	4.100	4.260	4.575	4.835	4.150	99.06	104.14	108.20	116.21	122.81	105.41
43/86*	4.200	4.400	4.560	4.875	5.135	4.450	106.68	111.76	115.82	123.83	130.43	113.03
44/88*	4.300	4.500	4.660	4.975	5.235	4.550	109.22	114.30	118.36	126.37	132.97	115.57
49/98*	4.800	5.000	5.160	5.475	5.735	5.050	121.92	127.00	131.06	139.07	145.67	128.27
50/100	4.900	5.100	5.260	5.575	5.835	5.150	124.46	129.54	133.60	141.61	148.21	130.81
55/110	5.400	5.600	5.760	6.075	6.335	5.650	137.16	142.24	146.30	154.31	160.91	143.51
60/120	5.900	6.100	6.260	6.575	6.835	6.150	149.86	154.94	159.00	167.01	173.61	156.21
61/122	6.000	6.200	6.360	6.675	6.935	6.250	152.40	157.48	161.54	169.55	176.15	158.75
65/130*	6.400	6.600	6.760	7.075	7.335	6.650	162.56	167.64	171.70	179.71	186.31	168.91
70/140	6.900	7.100	7.260	7.575	7.835	7.150	175.26	180.34	184.40	192.41	199.01	181.61

* Consult factory for availability.