



Metal oxide varistor

ThermoFuse varistor (AdvancedD series)

Series/Type: ETFV14K***E2
Ordering code: B72214T2***K101
Date: 2007-04-26
Version: b

Applications

Overvoltage protection with integrated thermal fuse.

Suitable for use in industrial and household appliance applications.

Nomenclature

- ETFV = EPCOS ThermoFuse varistor
 14 = Rated disk diameter (mm)
 K = Tolerance of V_V at 1 mA: $\pm 10\%$
 *** = Max. AC voltage (see table on page 3)
 E2 = Energy absorption characteristics, AdvancedE series

Dimensional drawings in mm

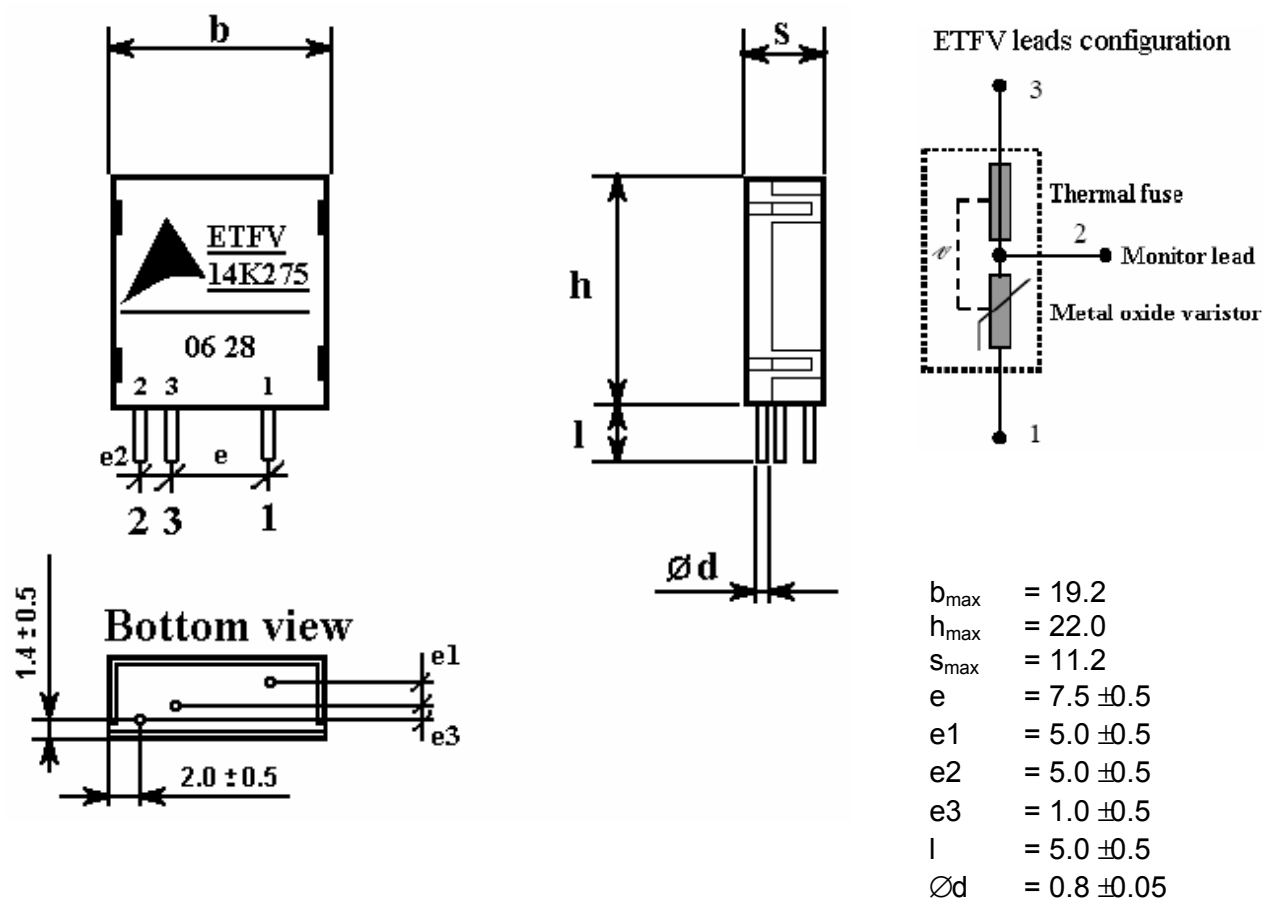

Electrical data

Maximum ratings (85 °C)

Ordering code	Type	Max. operating AC voltage [V]	Max. operating DC voltage [V]	Surge current (8/20 μ s) 1 time [A]	Energy absorption (2 ms) 1 time [J]	Average power dissipation [W]
B72214T2131K101	ETFV14K130E2	130	170	6000	50	0.6
B72214T2141K101	ETFV14K140E2	140	180	6000	55	0.6
B72214T2151K101	ETFV14K150E2	150	200	6000	60	0.6
B72214T2171K101	ETFV14K175E2	175	225	6000	70	0.6
B72214T2211K101	ETFV14K210E2	210	270	6000	80	0.6
B72214T2231K101	ETFV14K230E2	230	300	6000	90	0.6
B72214T2251K101	ETFV14K250E2	250	320	6000	100	0.6
B72214T2271K101	ETFV14K275E2	275	350	6000	110	0.6
B72214T2301K101	ETFV14K300E2	300	385	6000	125	0.6
B72214T2321K101	ETFV14K320E2	320	420	6000	136	0.6
B72214T2351K101	ETFV14K350E2	350	460	6000	136	0.6
B72214T2381K101	ETFV14K385E2	385	505	6000	136	0.6
B72214T2421K101	ETFV14K420E2	420	560	6000	136	0.6

Characteristics (25 °C)

Ordering code	Type	Varistor voltage at 1 mA [V]	Clamping voltage at 50 A (8/20 μs) [V]	Typ. capacitance at 1 kHz [pF]
B72214T2131K101	ETFV14K130E2	205 ±10%	340	650
B72214T2141K101	ETFV14K140E2	220 ±10%	360	610
B72214T2151K101	ETFV14K150E2	240 ±10%	395	570
B72214T2171K101	ETFV14K175E2	270 ±10%	455	490
B72214T2211K101	ETFV14K210E2	330 ±10%	545	410
B72214T2231K101	ETFV14K230E2	360 ±10%	595	385
B72214T2251K101	ETFV14K250E2	390 ±10%	650	350
B72214T2271K101	ETFV14K275E2	430 ±10%	710	320
B72214T2301K101	ETFV14K300E2	470 ±10%	775	300
B72214T2321K101	ETFV14K320E2	510 ±10%	840	280
B72214T2351K101	ETFV14K350E2	560 ±10%	910	260
B72214T2381K101	ETFV14K385E2	620 ±10%	1025	240
B72214T2421K101	ETFV14K420E2	680 ±10%	1120	220

v/i characteristic

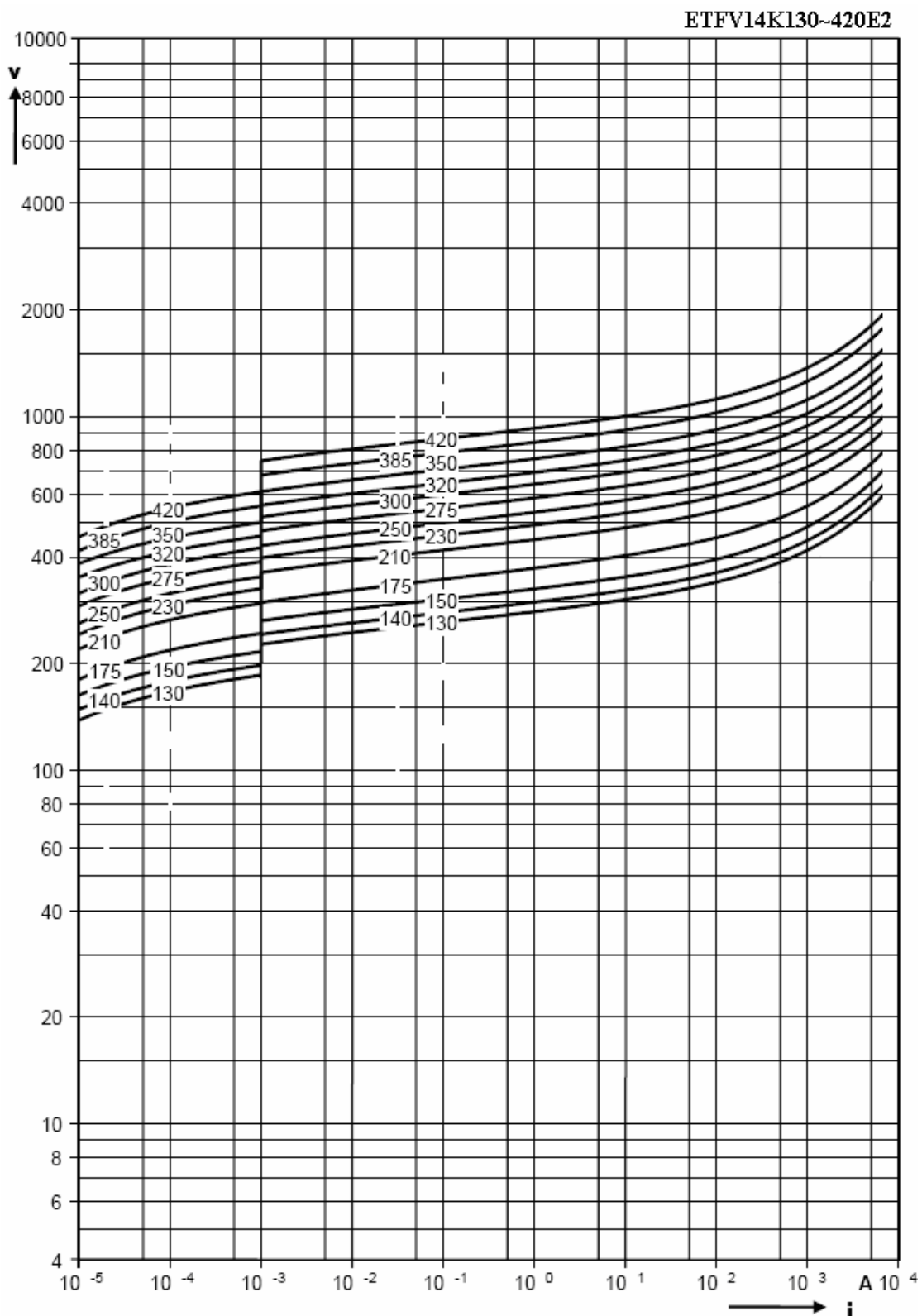

Maximum surge current $i_{max} = f(t_r, \text{pulse train})$

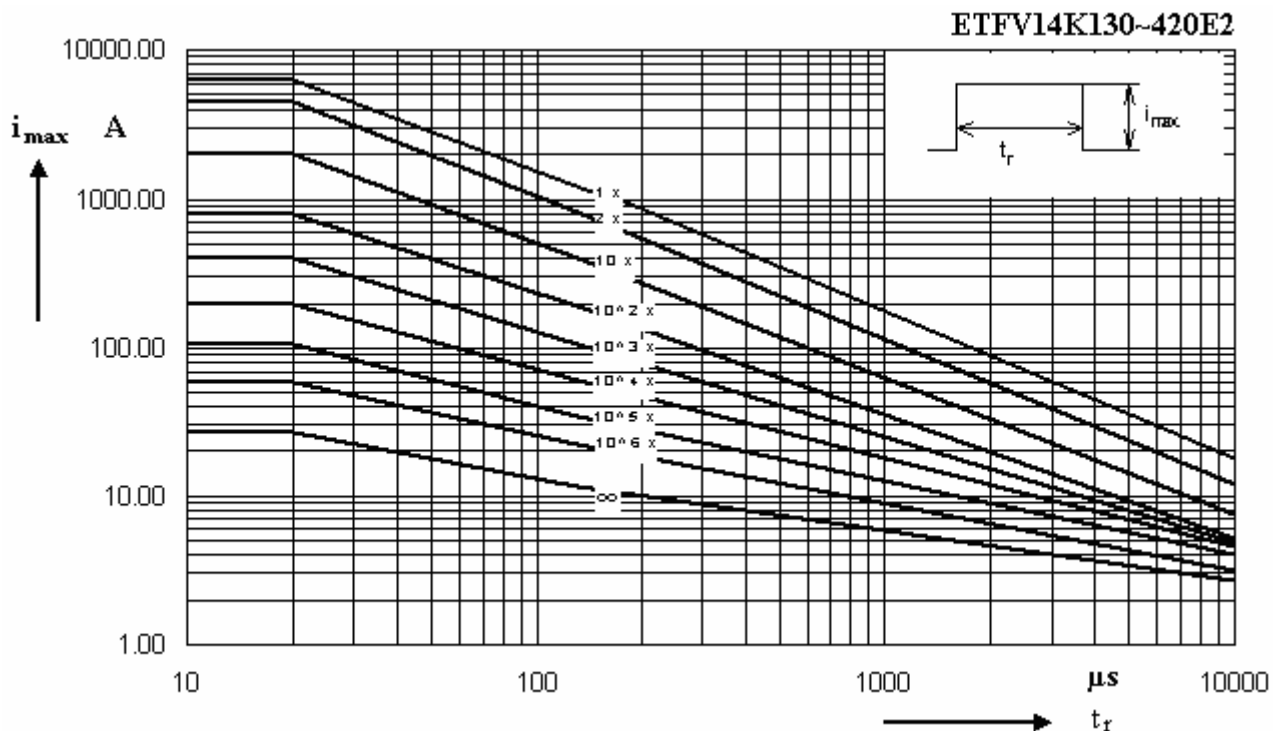

Typical application

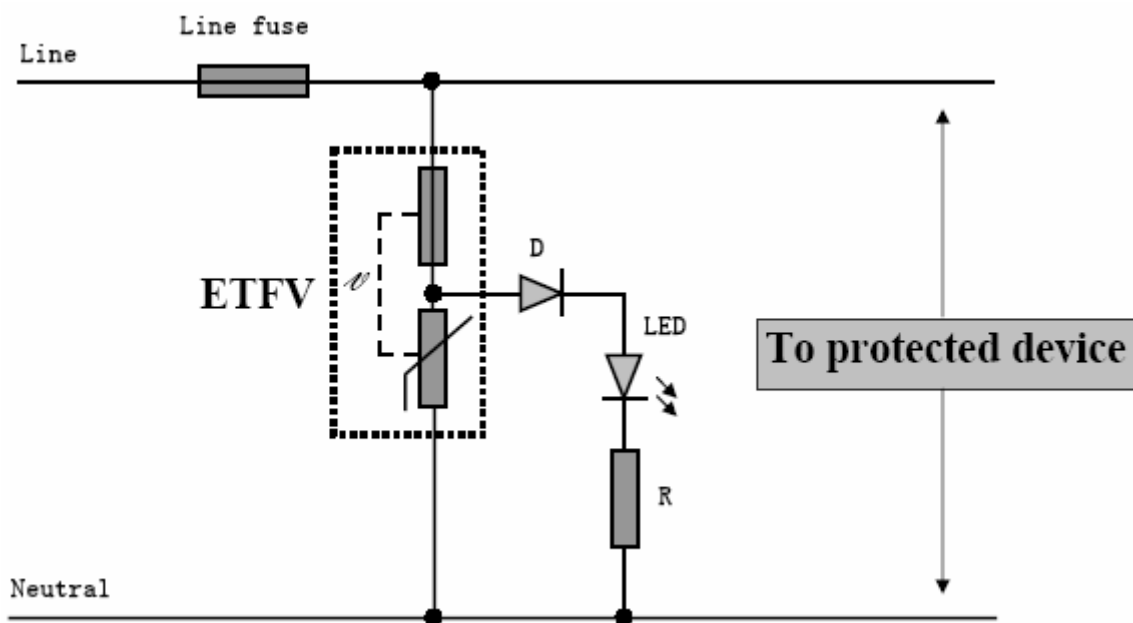

Typical wave soldering curve

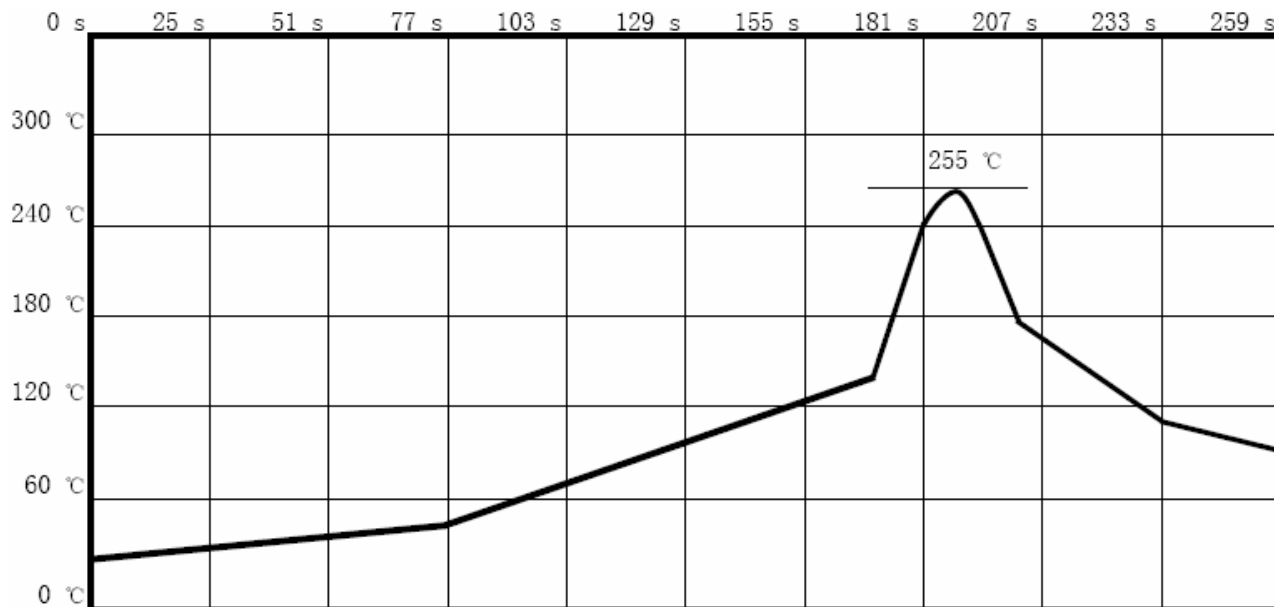

Typical thermal characteristic

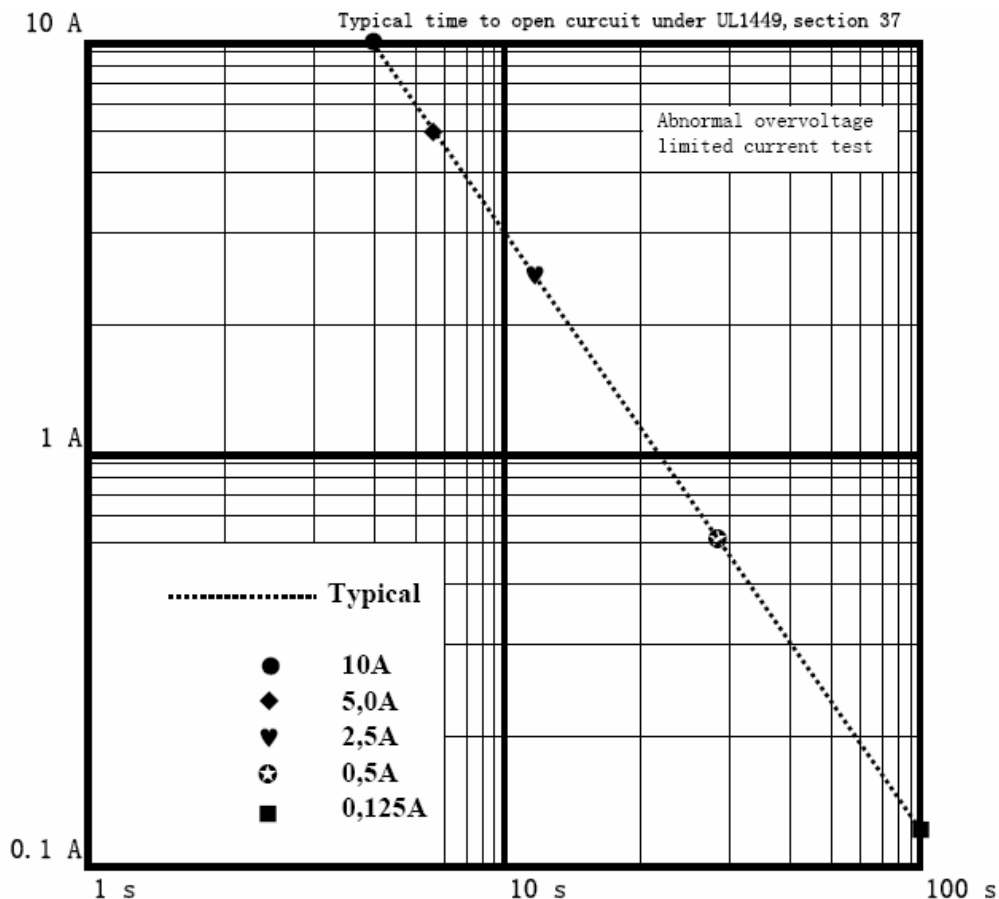

Reliability data, electrical

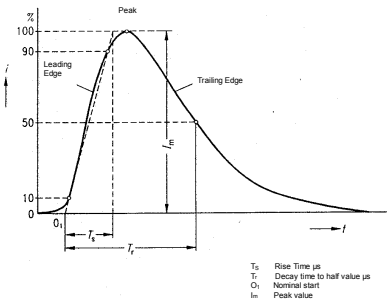
Characteristics	Test methods / Description	Specifications
Varistor voltage	The voltage between two terminals with the specified measuring current applied is called V_V (1 mA _{DC} @ 0.2 ... 2 s).	To meet the specified value.
Clamping voltage	<p>The maximum voltage between two terminals with the specified standard impulse current (8/20 μs) illustrated below applied.</p>  <p> <small> T_c Rise Time μs T_d Decay time to half value μs O₁ Nominal start I_m Peak value </small> </p>	To meet the specified value.
Surge current derating, 8/20 μs	CECC 42 000, test C 2.1 100 surge currents (8/20 μs), unipolar, interval 30 s, amplitude corresponding to derating curve for 20 μs	$ \Delta V/V (1 \text{ mA}) \leq 10\%$ (measured in direction of surge current) No visible damage
Surge current derating, 2 ms	CECC 42 000, test C 2.1 100 surge currents (2 ms), unipolar, interval 120 s, amplitude corresponding to derating curve for 2 ms	$ \Delta V/V (1 \text{ mA}) \leq 10\%$ (measured in direction of surge current) No visible damage

Reliability data, mechanical

Characteristics	Test methods/Description	Specifications
Solderability	IEC 60068-2-20 test Ta, method 1, 245 °C, 3 s: After dipping the terminals to a depth of approximately 3 mm from the body in a soldering bath of 245 ±5 °C for 3 ±0.3 s, the terminals shall be visually examined.	The inspection shall be carried out under adequate light with normal eyesight or with the assistance of a magnifier capable of giving a magnification of 4 times to 10 times. The dipped surface shall be covered with a smooth and bright solder coating with no more than small amounts of scattered imperfections such as pinholes or un-wetted or de-wetted areas. These imperfections shall not be concentrated in one area.
Resistance to soldering heat	IEC 60068-2-20 test Tb, method 1 A, 260 °C, 10 s: Each lead shall be dipped into a solder bath having a temperature of 260 ±5 °C to a point 2.0 to 2.5 mm from the body of the unit, be held there for 10 ±1 s and then be stored at room temperature and normal humidity for 1 to 2 hours. The change of V_v and mechanical damage shall be examined.	$ \Delta V/V (1 \text{ mA}) \leq 5\%$ No visible damage

Reliability data, environmental

Characteristics	Test methods/Description	Specifications												
Max. AC operating voltage	CECC 42 000, test 4.20 1000 h at 85 ±2 °C): After being continuously applied the maximum allowable voltage at 85 ±2 °C for 1000 hours, the specimen shall be stored at room temperature and normal humidity for 1 to 2 hours. Thereafter, the change of V _v shall be measured.	Δ V/V (1 mA) ≤10%												
Damp heat, steady state	IEC 60068-2-3 56 days, 40 °C, 93% r.H.: The specimen shall be subjected to 40 ±2 °C, 90 to 95% r.H. for 56 days, then stored at room temperature and normal humidity for 1 to 2 hours. Thereafter, the change of V _v shall be measured.	Δ V/V (1 mA) ≤10%												
Climatic sequence	CECC 42 000, test 4.16 The specimen shall be subjected to: a) dry heat at +85 °C, 16 h b) damp heat, 1st cycle: 55 °C/25 °C, 93% r.H., 24 h c) cold, -40 °C, 2 h d) damp heat, additional 5 cycles: 55/25 °C, 93% r.H., 24 h/cycle Then the specimen shall be stored at room temperature and normal humidity for 1 to 2 hours. Thereafter, the change of V _v shall be measured.	Δ V/V (1 mA) ≤10%												
Fast temperature cycling	IEC 60068-2-14, test Na, +85/-40 °C dwell time 30 min, 5 cycles: The temperature cycle shown below shall be repeated 5 times. Then the specimen shall be stored at room temperature and normal humidity for 1 to 2 hours. The change of V _v and mechanical damage shall be examined. <table border="1" style="margin-left: auto; margin-right: auto;"> <thead> <tr> <th>Step</th> <th>Temperature (°C)</th> <th>Period (min.)</th> </tr> </thead> <tbody> <tr> <td>1</td> <td>-40 ±3</td> <td>30 ±3</td> </tr> <tr> <td>2</td> <td>transition time</td> <td><10 s</td> </tr> <tr> <td>3</td> <td>+85 ±2</td> <td>30 ±3</td> </tr> </tbody> </table>	Step	Temperature (°C)	Period (min.)	1	-40 ±3	30 ±3	2	transition time	<10 s	3	+85 ±2	30 ±3	Δ V/V (1 mA) ≤5% No visible damage
Step	Temperature (°C)	Period (min.)												
1	-40 ±3	30 ±3												
2	transition time	<10 s												
3	+85 ±2	30 ±3												

Important notes

The following applies to all products named in this publication:

1. Some parts of this publication contain **statements about the suitability of our products for certain areas of application**. These statements are based on our knowledge of typical requirements that are often placed on our products in the areas of application concerned. We nevertheless expressly point out **that such statements cannot be regarded as binding statements about the suitability of our products for a particular customer application**. As a rule, EPCOS is either unfamiliar with individual customer applications or less familiar with them than the customers themselves. For these reasons, it is always ultimately incumbent on the customer to check and decide whether an EPCOS product with the properties described in the product specification is suitable for use in a particular customer application.
2. We also point out that **in individual cases, a malfunction of passive electronic components or failure before the end of their usual service life cannot be completely ruled out in the current state of the art, even if they are operated as specified**. In customer applications requiring a very high level of operational safety and especially in customer applications in which the malfunction or failure of a passive electronic component could endanger human life or health (e.g. in accident prevention or life-saving systems), it must therefore be ensured by means of suitable design of the customer application or other action taken by the customer (e.g. installation of protective circuitry or redundancy) that no injury or damage is sustained by third parties in the event of malfunction or failure of a passive electronic component.
3. **The warnings, cautions and product-specific notes must be observed.**
4. In order to satisfy certain technical requirements, **some of the products described in this publication may contain substances subject to restrictions in certain jurisdictions (e.g. because they are classed as “hazardous”)**. Useful information on this will be found in our Material Data Sheets on the Internet (www.epcos.com/material). Should you have any more detailed questions, please contact our sales offices.
5. We constantly strive to improve our products. Consequently, **the products described in this publication may change from time to time**. The same is true of the corresponding product specifications. Please check therefore to what extent product descriptions and specifications contained in this publication are still applicable before or when you place an order.

We also **reserve the right to discontinue production and delivery of products**. Consequently, we cannot guarantee that all products named in this publication will always be available.

6. Unless otherwise agreed in individual contracts, **all orders are subject to the current version of the “General Terms of Delivery for Products and Services in the Electrical Industry” published by the German Electrical and Electronics Industry Association (ZVEI)**.
7. The trade names EPCOS, BAOKE, Alu-X, CeraDiode, CSSP, MiniBlue, MLSC, MotorCap, PhaseCap, PhaseMod, SIFERRIT, SIFI, SIKOREL, SilverCap, SIMID, SineFormer, SIOV, SIP5D, SIP5K, ThermoFuse, WindCap are **trademarks registered or pending** in Europe and in other countries. Further information will be found on the Internet at www.epcos.com/trademarks.