

REMINDERS

Please read this before using the product.

SAFETY REMINDERS

REMINDERS

1. If you intend to use a product listed in this catalog for a purpose that may cause loss of life or other damage, you must contact our company's sales window.
2. We may modify products or discontinue production of a product listed in this catalog without prior notification.
3. We provide "Delivery Specification" that explain precautions for the specifications and safety of each product listed in this catalog. We strongly recommend that you exchange these delivery specifications with customers that use one of these products.
4. If you plan to export a product listed in this catalog, keep in mind that it may be a restricted item according to the "Foreign Exchange and Foreign Trade Control Law". In such cases, it is necessary to acquire export permission in harmony with this law.
5. Any reproduction or transferring of the contents of this catalog is prohibited without prior permission from our company.
6. We are not responsible for problems that occur related to the intellectual property rights or other rights of our company or a third party when you use a product listed in this catalog. We do not grant license of these rights.
7. This catalog only applies to products purchased through our company or one of our company's official agencies. This catalog does not apply to products that are purchased through other third parties.
8. The descriptions in this catalog apply as of June 2008.

3-terminal Feed Through Multilayer Ceramic Chip Capacitors

CKD Series

Conformity to RoHS Directive

FEATURES

- These small low-cost filters are used for meeting EMC requirements.
- Can be used up to even higher frequencies due to low parasitic inductance.
- Optimized for use as a noise bypass capacitors for signal and power source circuits.

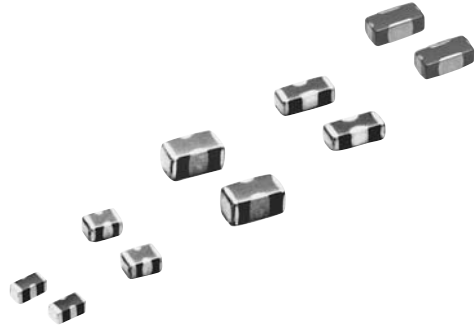

APPLICATIONS

For digital and analog signal line noise bypassing signal line

PRODUCT IDENTIFICATION

CKD510JB 1H 220 S □
 (1) (2) (3) (4) (5)

(1) Series name

CKD110JB	3.20×1.25×0.85mm
CKD310JB	3.20×1.60×1.30mm
CKD510JB	2.00×1.25×0.85mm
CKD610JB	1.60×0.80×0.80mm
CKD61BJB	1.60×0.80×0.60mm

(2) Rated voltage Edc

0J	6.3V
1A	10V
1C	16V
1E	25V
1H	50V

(3) Nominal capacitance

The capacitance is expressed in three digit codes and in units of pico farads (pF).

The first and second digits identify the first and second significant figures of the capacitance.

The third digit identifies the multiplier.

R designates a decimal point.

220	22pF
101	100pF
222	2,200pF
473	47,000pF

(4) Capacitance tolerance

S	+50, -20%
---	-----------

(5) Packaging style

T	Taping (reel)
B	Bulk

SHAPES AND DIMENSIONS

CKD110/310/510/610JB

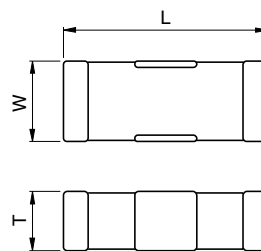

CKD61BJB

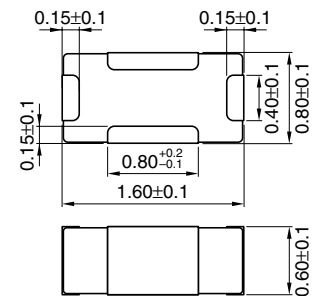

Dimensions in mm

Type	L	W	T
CKD110JB	3.20	1.25	0.85
CKD310JB	3.20	1.60	1.30
CKD510JB	2.00	1.25	0.85
CKD610JB	1.60	0.80	0.80

CIRCUIT DIAGRAM

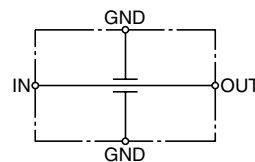

•No polarity

• Conformity to RoHS Directive: This means that, in conformity with EU Directive 2002/95/EC, lead, cadmium, mercury, hexavalent chromium, and specific bromine-based flame retardants, PBB and PBDE, have not been used, except for exempted applications.

• All specifications are subject to change without notice.
 Please read the precautions before using this catalog.

ELECTRICAL CHARACTERISTICS

FOR SIGNAL LINE

CKD510JB TYPE

RATED VOLTAGE Edc: 50V

Capacitance (pF)	Tolerance (%)	Rated current Idc (mA)max.	Insulation resistance (M Ω)min.	DC resistance* (Ω)max.	Part No.
22	+50, -20	400	1000	0.5	CKD510JB1H220S
47	+50, -20	400	1000	0.5	CKD510JB1H470S
100	+50, -20	400	1000	0.5	CKD510JB1H101S
220	+50, -20	400	1000	0.5	CKD510JB1H221S
470	+50, -20	400	1000	0.5	CKD510JB1H471S
1,000	+50, -20	400	1000	0.5	CKD510JB1H102S
2,200	+50, -20	400	1000	0.5	CKD510JB1H222S
4,700	+50, -20	400	1000	0.5	CKD510JB1H472S

* DC resistance value is between feed-through terminals.

CKD110JB TYPE

RATED VOLTAGE Edc: 25V

Capacitance (pF)	Tolerance (%)	Rated current Idc (mA)max.	Insulation resistance (M Ω)min.	DC resistance* (Ω)max.	Part No.
22	+50, -20	200	1000	0.6	CKD110JB1E220S
47	+50, -20	200	1000	0.6	CKD110JB1E470S
100	+50, -20	200	1000	0.6	CKD110JB1E101S
220	+50, -20	200	1000	0.6	CKD110JB1E221S
470	+50, -20	200	1000	0.6	CKD110JB1E471S
1,000	+50, -20	200	1000	0.6	CKD110JB1E102S
2,200	+50, -20	200	1000	0.6	CKD110JB1E222S
4,700	+50, -20	200	1000	0.6	CKD110JB1E472S
10,000	+50, -20	500	1000	0.3	CKD110JB1E103S
22,000	+50, -20	500	1000	0.3	CKD110JB1E223S
47,000	+50, -20	500	1000	0.3	CKD110JB1E473S
100,000	+50, -20	500	1000	0.3	CKD110JB1E104S

* DC resistance value is between feed-through terminals.

FOR POWER LINE

CKD61BJB TYPE

RATED VOLTAGE Edc: 6.3V

Capacitance (pF)	Tolerance (%)	Rated current Idc (mA)max.	Insulation resistance (M Ω)min.	DC resistance* (Ω)max.	Part No.
470,000	+50, -20	2000	100	0.03	CKD61BJB474S

* DC resistance value is between feed-through terminals.

CKD610JB TYPE

RATED VOLTAGE Edc: 6.3V

Capacitance (pF)	Tolerance (%)	Rated current Idc (mA)max.	Insulation resistance (M Ω)min.	DC resistance* (Ω)max.	Part No.
1,000,000	+50, -20	2000	100	0.012	CKD610JB0J105S

* DC resistance value is between feed-through terminals.

CKD510JB TYPE

RATED VOLTAGE Edc: 25V

Capacitance (pF)	Tolerance (%)	Rated current Idc (mA)max.	Insulation resistance (M Ω)min.	DC resistance* (Ω)max.	Part No.
10,000	+50, -20	1000	1000	0.08	CKD510JB1E103S
22,000	+50, -20	1000	1000	0.08	CKD510JB1E223S
47,000	+50, -20	1000	1000	0.08	CKD510JB1E473S
100,000	+50, -20	1000	1000	0.08	CKD510JB1E104S

* DC resistance value is between feed-through terminals.

RATED VOLTAGE Edc: 10V

Capacitance (pF)	Tolerance (%)	Rated current Idc (mA)max.	Insulation resistance (M Ω)min.	DC resistance* (Ω)max.	Part No.
1,000,000 [1 μ F]	+50, -20	2000	1000	0.012	CKD510JB1A105S

* DC resistance value is between feed-through terminals.

CKD310JB TYPE

RATED VOLTAGE Edc: 16V

Capacitance (pF)	Tolerance (%)	Rated current Idc (mA)max.	Insulation resistance (M Ω)min.	DC resistance* (Ω)max.	Part No.
100,000	+50, -20	2000	100	0.04	CKD310JB1C104S
220,000	+50, -20	2000	100	0.04	CKD310JB1C224S
470,000	+50, -20	2000	100	0.04	CKD310JB1C474S
1,000,000 [1 μ F]	+50, -20	2000	100	0.04	CKD310JB1C105S

* DC resistance value is between feed-through terminals.

RATED VOLTAGE Edc: 6.3V

Capacitance (pF)	Tolerance (%)	Rated current Idc (mA)max.	Insulation resistance (M Ω)min.	DC resistance* (Ω)max.	Part No.
22,000,000 [22 μ F]	+50, -20	4000	4.5	0.012	CKD310JB0J226S

* DC resistance value is between feed-through terminals.

TYPICAL ELECTRICAL CHARACTERISTICS
ATTENUATION vs. FREQUENCY CHARACTERISTICS
COMPARISON WITH EXISTING PRODUCTS

Excellent noise bypass effect is displayed in higher frequency range compared with ordinary chip capacitors.

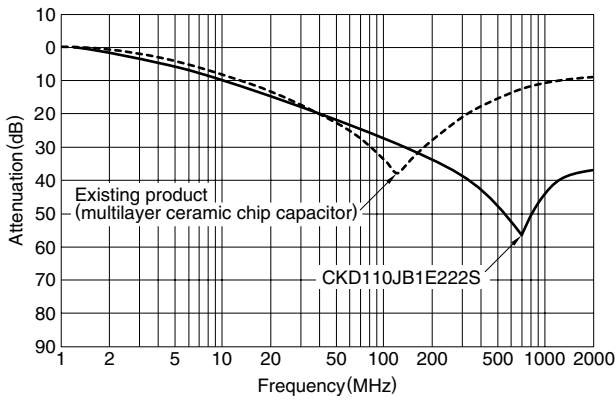

CKD110JB TYPE

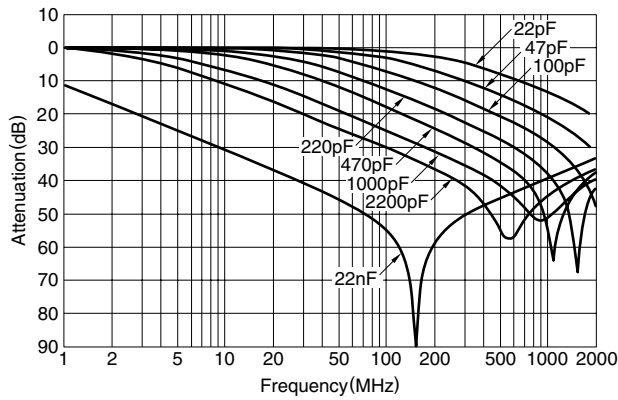

CKD310JB TYPE

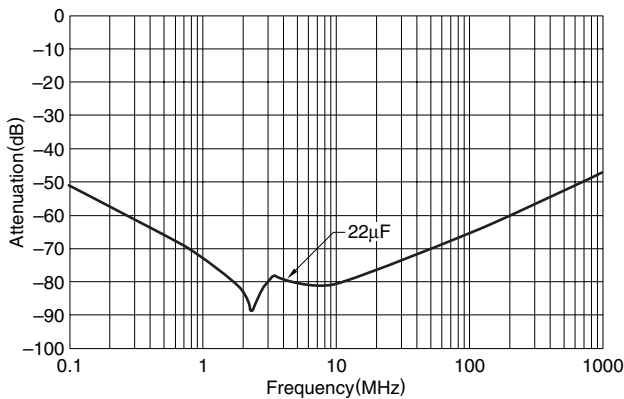

MEASURING CIRCUIT

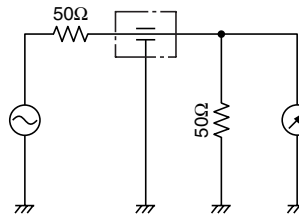

EXAMPLES OF NOISE COUNTERMEASURE

Purpose	1. Noise countermeasure on IC power supply lines: Eliminates noise occurring on supply lines to assure a stable voltage supply for proper IC operation.	2. Radiation noise countermeasure on signals lines: Attenuates superfluous high-frequency content of signals to prevent noise radiation.
---------	---	--

Type	CKD310JB, CKD610JB (High capacity type product)	CKD110JB, CKD510JB
------	--	--------------------

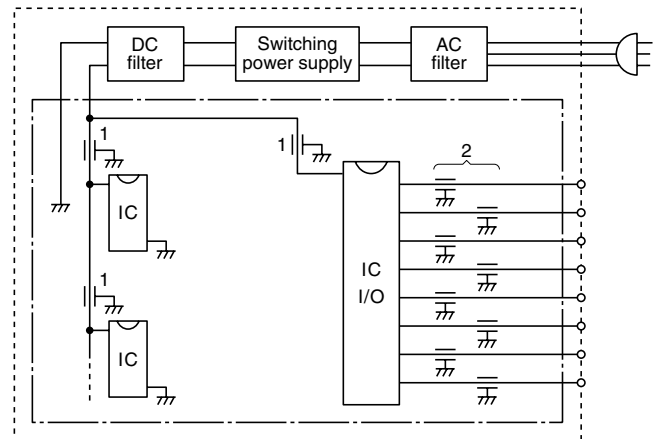

• For more information about products with other capacitance or other data, please contact us.

• All specifications are subject to change without notice.
 Please read the precautions before using this catalog.