

HIGH GRADE Specification HIGH RELIABILITY series

# SPI BUS Serial EEPROMs



Supply voltage 1.8V~5.5V  
Operating temperature -40°C~+85°C type

BR25L010-W, BR25L020-W, BR25L040-W, BR25L080-W, BR25L160-W, BR25L320-W, BR25L640-W

### ● Description

BR25L□□□-W series is a serial EEPROM of SPI BUS interface method.

### ● Features

- High speed clock action up to 5MHz (Max.)
- Wait function by HOLD terminal
- Part or whole of memory arrays settable as read only memory area by program
- 1.8 ~ 5.5V single power source action most suitable for battery use
- Page write mode useful for initial value write at factory shipment
- Highly reliable connection by Au pad and Au wire
- For SPI bus interface (CPOL, CPHA) = (0, 0), (1, 1)
- Auto erase and auto end function at data rewrite
- Low current consumption
  - At write action (5V) : 1.5mA (Typ.)
  - At read action (5V) : 1.0mA (Typ.)
  - At standby action (5V) : 0.1μA (Typ.)
- Address auto increment function at read action
- Write mistake prevention function
  - Write prohibition at power on
  - Write prohibition by command code (WRDI)
  - Write prohibition by WP pin
  - Write prohibition block setting by status registers (BP1, BP0)
  - Write mistake prevention function at low voltage
- SOP8, SOP-J8, SSOP-B8, TSSOP-B8, MSOP8 TSSOP-B8J package \*1 \*2
- Data at shipment Memory array : FFh, status register WPEN, BP1, BP0 : 0
- Data kept for 40 years
- Data rewrite up to 1,000,000 times

\*1 BR25L080/160-W : SOP8, SOP-J8, SSOP-B8, TSSOP-B8

\*2 BR25L320/640-W : SOP8, SOP-J8

### ● Page write

Number of pages	16 Byte	32 Byte
Product number	BR25L010-W BR25L020-W BR25L040-W	BR25L080-W BR25L160-W BR25L320-W BR25L640-W

### ● BR25L series

Capacity	Bit format	Type	Power source voltage	SOP8	SOP-J8	SSOP-B8	TSSOP-B8	MSOP8	TSSOP-B8J
1Kbit	128 × 8	BR25L010-W	1.8 ~ 5.5V	●	●	●	●	●	●
2Kbit	256 × 8	BR25L020-W	1.8 ~ 5.5V	●	●	●	●	●	●
4Kbit	512 × 8	BR25L040-W	1.8 ~ 5.5V	●	●	●	●	●	●
8Kbit	1K × 8	BR25L080-W	1.8 ~ 5.5V	●	●	●	●		
16Kbit	2K × 8	BR25L160-W	1.8 ~ 5.5V	●	●	●	●		
32Kbit	4K × 8	BR25L320-W	1.8 ~ 5.5V	●	●				
64Kbit	8K × 8	BR25L640-W	1.8 ~ 5.5V	●	●				

● Absolute maximum ratings (Ta = 25°C)

Parameter	Symbol	Limits	Unit
Impressed voltage	Vcc	-0.3 ~ +6.5	V
Permissible dissipation	Pd	450(SOP8) *1	mW
		450(SOP-J8) *2	
		300(SSOP-B8) *3	
		330(TSSOP-B8) *4	
		310(MSOP8) *5	
		310(TSSOP-B8J) *6	
Storage temperature range	Tstg	-65 ~ +125	°C
Operating temperature range	Topr	-40 ~ +85	°C
Terminal voltage	-	-0.3 ~ Vcc+0.3	V

\*When using at Ta = 25°C or higher, 4.5mW (\*1, \*2), 3.0mW (\*3), 3.3mW(\*4), 3.1mW (\*5, \*6) to be reduced per 1°C

● Recommended action conditions

Parameter	Symbol	Limits	Unit
Power source voltage	Vcc	1.8 ~ 5.5	V
Input voltage	Vin	0 ~ Vcc	

● Memory cell characteristics (Ta=25°C, Vcc=1.8 ~ 5.5V)

Parameter	Limits			Unit
	Min.	Typ.	Max.	
Number of data rewrite times *1	1,000,000	-	-	Times
Data hold years *1	40	-	-	Years

\*1:Not 100% TESTED

● Input / output capacity (Ta=25°C, frequency=5MHz)

Parameter	Symbol	Conditions	Min.	Max.	Unit
Input capacity *1	CIN	VIN=GND	-	8	pF
Output capacity *1	COU	VOU=GND	-	8	pF

\*1:Not 100% TESTED

● Electrical characteristics (Unless otherwise specified, Ta = -40 ~ +85°C, Vcc = 1.8 ~ 5.5V)

Parameter	Symbol	Limits			Unit	Conditions
		Min.	Typ.	Max.		
"H" input voltage 1	VIH1	0.7x Vcc	-	Vcc +0.3	V	1.8≤Vcc≤5.5V
"L" input voltage 1	VIL1	-0.3	-	0.3x Vcc	V	1.8≤Vcc≤5.5V
"L" output voltage 1	VOL1	0	-	0.4	V	IOL=2.1mA(Vcc=2.5V ~ 5.5V)
"L" output voltage 2	VOL2	0	-	0.2	V	IOL=150μA(Vcc=1.8V ~ 2.5V)
"H" output voltage 1	VOH1	Vcc -0.5	-	Vcc	V	IOH=-0.4mA(Vcc=2.5V ~ 5.5V)
"H" output voltage 2	VOH2	Vcc -0.2	-	Vcc	V	IOH=-100μA(Vcc=1.8V ~ 2.5V)
Input leak current	ILI	-1	-	1	μA	VIN=0 ~ Vcc
Output leak current	ILO	-1	-	1	μA	VOU=0 ~ Vcc, CS=Vcc
Current consumption at write action	Icc1	-	-	1.0	mA	Vcc=1.8V, fSCK=2MHz, tE/W=5ms Byte write Page write Write status register
	Icc2	-	-	2.0	mA	Vcc=2.5V, fSCK=5MHz, tE/W=5ms Byte write Page write Write status register
	Icc3	-	-	3.0	mA	Vcc=5.5V, fSCK=5MHz, tE/W=5ms Byte write Page write Write status register
Current consumption at read action	Icc4	-	-	1.5	mA	Vcc=2.5V, fSCK=5MHz Read Read status register
	Icc5	-	-	2.0	mA	Vcc=5.5V, fSCK=5MHz Read Read status register
Standby current	ISB	-	-	2	μA	Vcc=5.5V CS=HOLD=WP=Vcc, SCK=SI=Vcc or =GND, SO=OPEN

\* Radiation resistance design is not made.

● Block diagram

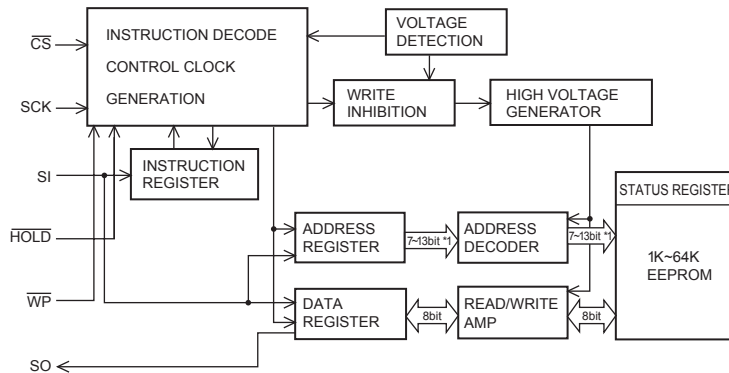

Fig.1 Block diagram

\*1 7bit : BR25L010-W  
8bit : BR25L020-W  
9bit : BR25L040-W  
10bit : BR25L080-W  
11bit : BR25L160-W  
12bit : BR25L320-W  
13bit : BR25L640-W

● Pin assignment and description

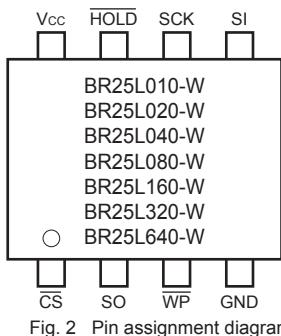

Fig. 2 Pin assignment diagram

Terminal name	Input/output	Function
Vcc	–	Power source to be connected
GND	–	All input / output reference voltage, 0V
$\overline{CS}$	Input	Chip select input
SCK	Input	Serial clock input
SI	Input	Start bit, ope code, address, and serial data input
SO	Output	Serial data output
$\overline{HOLD}$	Input	Hold input Command communications may be suspended temporarily (HOLD status).
$\overline{WP}$	Input	Write protect input Write command is prohibited.*1 Write status register command is prohibited.

\*1:BR25L010/020/040-W

● Operating timing characteristics

(Ta = -40 ~ +85°C, unless otherwise specified, load capacity CL1 100pF)

Parameter	Symbol	1.8≤Vcc<2.5V			2.5≤Vcc<5.5V			Unit
		Min.	Typ.	Max.	Min.	Typ.	Max.	
SCK frequency	fSCK	–	–	2	–	–	5	MHz
SCK high time	tSCKWH	200	–	–	85	–	–	ns
SCK low time	tSCKWL	200	–	–	85	–	–	ns
$\overline{CS}$ high time	tCS	200	–	–	85	–	–	ns
$\overline{CS}$ setup time	tCSS	200	–	–	90	–	–	ns
$\overline{CS}$ hold time	tCSH	200	–	–	85	–	–	ns
SCK setup time	tSCKS	200	–	–	90	–	–	ns
SCK hold time	tSCKH	200	–	–	90	–	–	ns
SI setup time	tDIS	40	–	–	20	–	–	ns
SI hold time	tDIH	50	–	–	40	–	–	ns
Data output delay time 1	tPD1	–	–	150	–	–	70	ns
Data output delay time 2 (CL2=30pF)	tPD2	–	–	145	–	–	55	ns
Output hold time	tOH	0	–	–	0	–	–	ns
Output disable time	tOZ	–	–	250	–	–	100	ns
$\overline{HOLD}$ setting setup time	tHFS	120	–	–	60	–	–	ns
$\overline{HOLD}$ setting hold time	tHFH	90	–	–	40	–	–	ns
$\overline{HOLD}$ release setup time	tHRS	120	–	–	60	–	–	ns
$\overline{HOLD}$ release hold time	tHRH	140	–	–	70	–	–	ns
Time from $\overline{HOLD}$ to output High-Z	tHOZ	–	–	250	–	–	100	ns
Time from $\overline{HOLD}$ to output change	tHPD	–	–	150	–	–	70	ns
SCK rise time *1	tRC	–	–	1	–	–	1	μs
SCK fall time *1	tFC	–	–	1	–	–	1	μs
OUTPUT rise time *1	tRO	–	–	100	–	–	50	ns
OUTPUT fall time *1	tFO	–	–	100	–	–	50	ns
Write time	tE/W	–	–	5	–	–	5	ms

\*1NOT 100% TESTED

● Sync data input / output timing

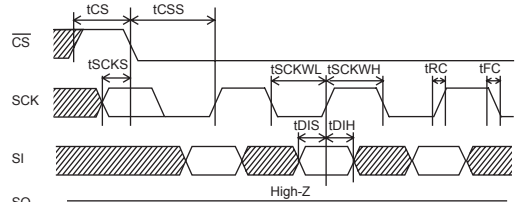

Fig. 3 Input timing

SI is taken into IC inside in sync with data rise edge of SCK. Input address and data from the most significant bit MSB.

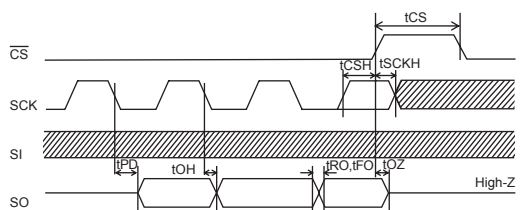

Fig. 4 Input / output timing

SO is output in sync with data fall edge of SCK. Data is output from the most significant bit MSB.

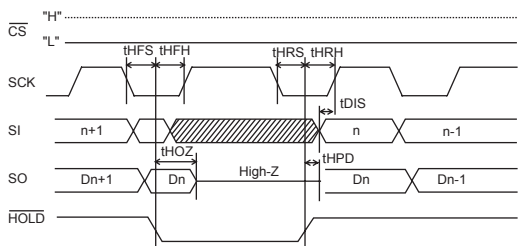

Fig. 5 HOLD timing

● AC measurement conditions

Parameter	Symbol	Limits			Unit
		Min.	Typ.	Max.	
Load capacity 1	CL1	–	–	100	pF
Load capacity 2	CL2	–	–	30	pF
Input rise time	–	–	–	50	ns
Input fall time	–	–	–	50	ns
Input voltage	–	0.2Vcc/0.8Vcc			V
Input / output judgment voltage	–	0.3Vcc/0.7Vcc			V

● Characteristic data (The following characteristic data are Typ. values.)

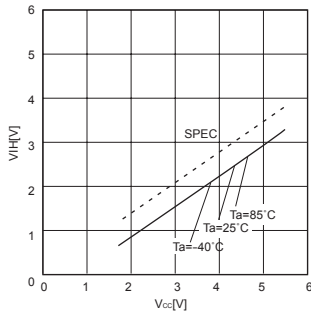

Fig.6 "H" input voltage  $V_{IH}(\overline{CS}, SCK, SI, \overline{HOLD}, \overline{WP})$

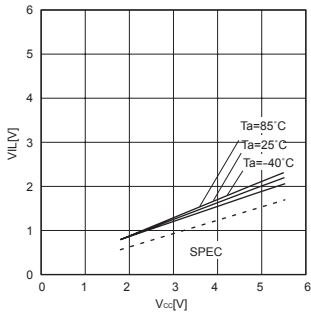

Fig.7 "L" input voltage  $V_{IL}(\overline{CS}, SCK, SI, \overline{HOLD}, \overline{WP})$

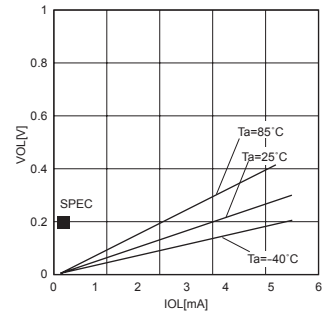

Fig.8 "L" output voltage  $V_{OL-IOL}(V_{CC}=1.8V)$

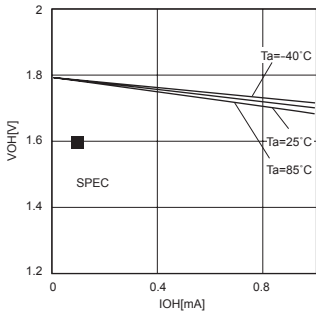

Fig.9 "H" output voltage  $V_{OH-IOH}(V_{CC}=1.8V)$

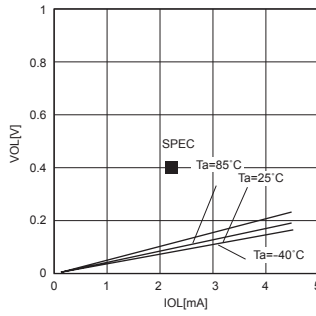

Fig.10 "L" output voltage  $V_{OL-IOL}(V_{CC}=2.5V)$

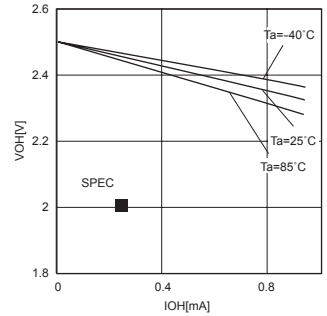

Fig.11 "H" output voltage  $V_{OH-IOH}(V_{CC}=2.5V)$

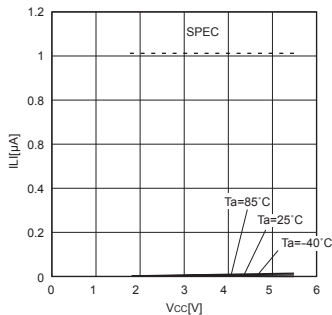

Fig.12 Input leak current  $I_{IL}(\overline{CS}, SCK, SI, \overline{WP}, \overline{HOLD})$

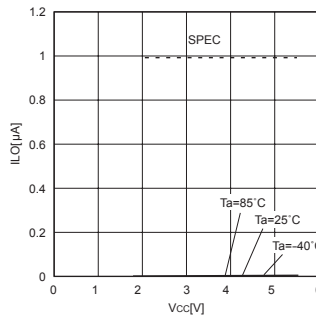

Fig.13 Output leak current  $I_{LO}(SO)$

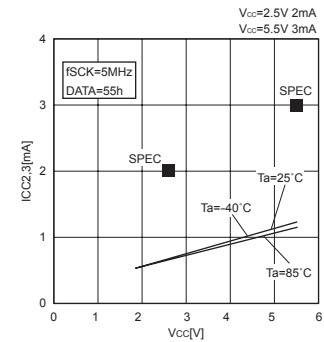

Fig.14 Current consumption at WRITE operation  $ICC_{2.3}(WRITE, PAGE WRITE, WRSR, fSCK=5MHz)$   
BR25L010-W, BR25L020-W, BR25L040-W

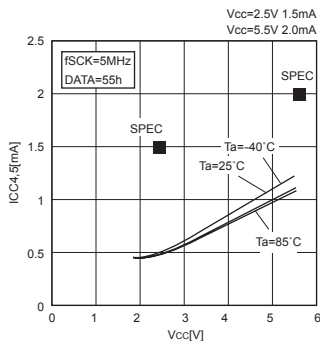

Fig.15 Consumption current at READ operation  $ICC_{4.5}(READ, WRSR, fSCK=5MHz)$

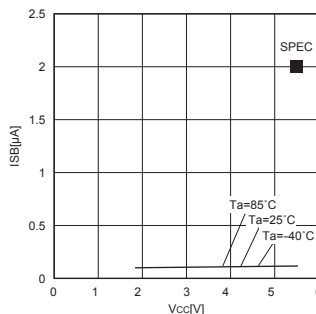

Fig.16 Consumption current at standby operation ISB

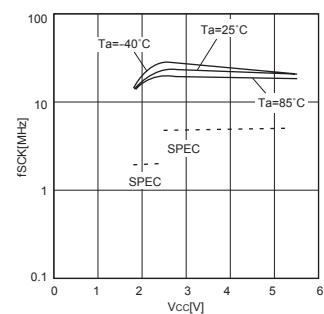

Fig.17 SCK frequency  $f_{SCK}$

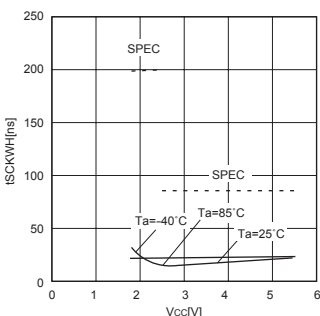

Fig.18 tSCK high time  $t_{SCKWH}$

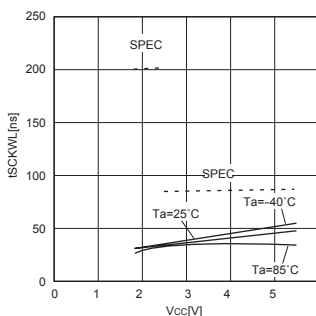

Fig.19 tSCK low time  $t_{SCKWL}$

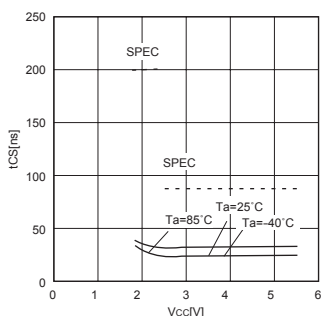

Fig.20  $\overline{CS}$  high time  $t_{CS}$

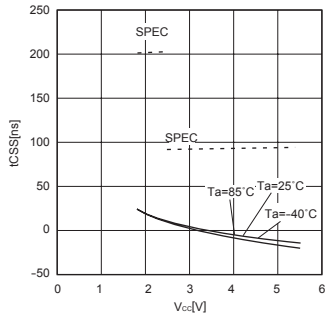

Fig.21 CS setup time tCSS

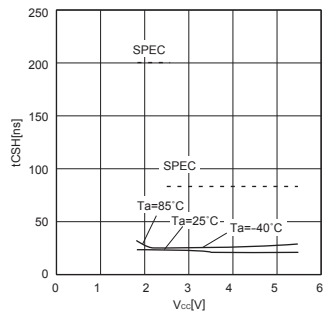

Fig.22 CS hold time tCSH

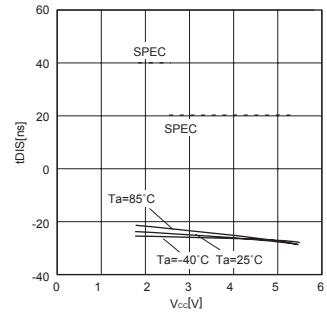

Fig.23 SI setup time tDIS

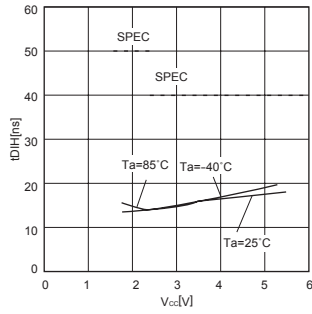

Fig.24 SI hold time tDIH

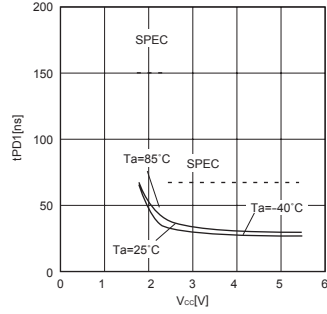

Fig.25 Data output delay time tPD1(CL=100pF)

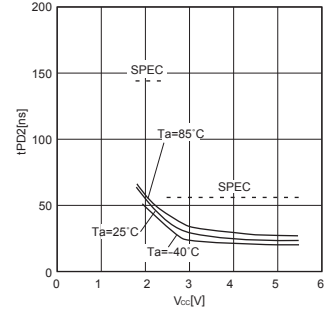

Fig.26 Data output delay time tPD2(CL=30pF)

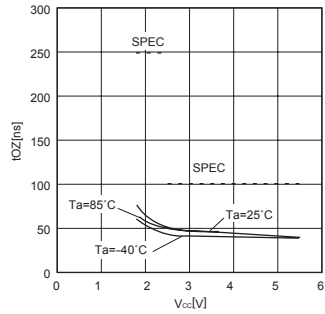

Fig.27 Output disable time tOZ

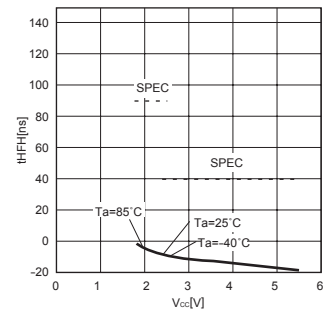

Fig.28 HOLD setting hold time tHFH

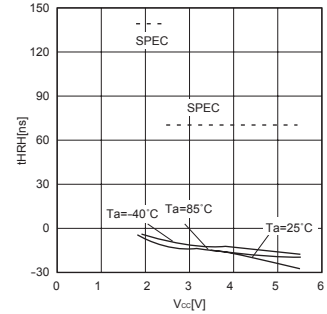

Fig.29 HOLD release hold time tHRH

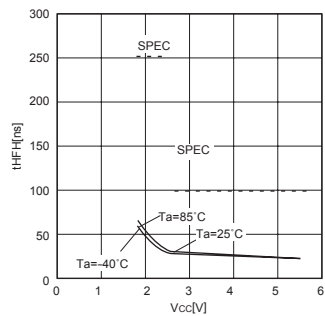

Fig.30 Time from HOLD to output High-Z tHOZ

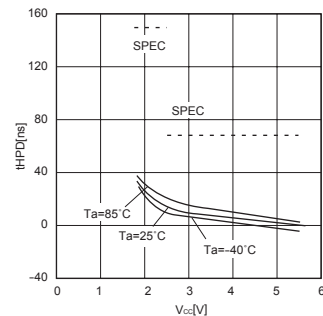

Fig.31 Time from HOLD to output change tHPD

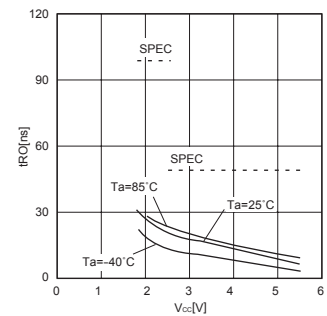

Fig.32 Output rise time tRO

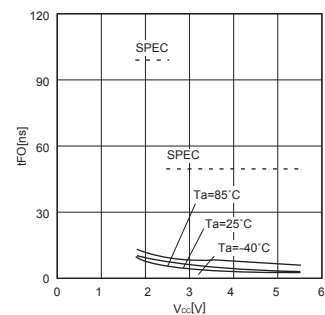

Fig.33 Output fall time

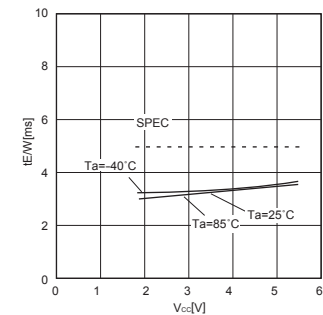

Fig.34 Write cycle time tE/W

● Features

○ Status registers

This IC has status registers. The status registers are of 8 bits and express the following parameters. BP0 and BP1 can be set by write status register command. These 2 bits are memorized into the EEPROM, therefore are valid even when power source is turned off.

Rewrite characteristics and data hold time are same as characteristics of the EEPROM.

WEN can be set by write enable command and write disable command. WEN becomes write disable status when power source is turned off.  $\bar{R}/B$  is for write confirmation, therefore cannot be set externally.

The value of status register can be read by read status command.

● Status registers

Product number	bit 7	bit 6	bit 5	bit 4	bit 3	bit 2	bit 1	bit 0
BR25L010-W	1	1	1	1	BP1	BP0	WEN	$\bar{R}/B$
BR25L020-W								
BR25L040-W								
BR25L080-W	WPEN	0	0	0	BP1	BP0	WEN	$\bar{R}/B$
BR25L160-W								
BR25L320-W								
BR25L640-W								

bit	Memory location	Function	Contents
WPEN	EEPROM	$\bar{W}P$ pin enable / disable designation bit WPEN = 0 = invalid WPEN = 1 = valid	This enables / disables the functions of $\bar{W}P$ pin.
BP1 BP0	EEPROM	EEPROM write disable block designation bit	This designates the write disable area of EEPROM. Write designation areas of product numbers are shown below.
WEN	Register	Write and write status register write enable / disable status confirmation bit WEN = 0 = prohibited WEN = 1 = permitted	
$\bar{R}/B$	Register	Write cycle status (READY / BUSY) status confirmation bit $\bar{R}/B=0=READY$ $\bar{R}/B=1=BUSY$	

● Write disable block setting

BP1	BP0	Write disable block						
		BR25L010-W	BR25L020-W	BR25L040-W	BR25L080-W	BR25L160-W	BR25L320-W	BR25L640-W
0	0	None	None	None	None	None	None	None
0	1	60h-7Fh	C0h-FFh	180h-1FFh	300h-3FFh	600h-7FFh	C00h-FFFh	1800h-1FFFh
1	0	40h-7Fh	80h-FFh	100h-1FFh	200h-3FFh	400h-7FFh	800h-FFFh	1000h-1FFFh
1	1	00h-7Fh	00h-FFh	000h-1FFh	000h-3FFh	000h-7FFh	000h-FFFh	0000h-1FFFh

○  $\bar{W}P$  pin

By setting  $\bar{W}P = LOW$ , write command is prohibited. As for BR25L080, 160, 320, 640-W, only when WPEN bit is set "1", the  $\bar{W}P$  pin functions become valid. And the write command to be disabled at this moment is WRSR. As for BR25L010, 020, 040-W, both WRITE and WRSR commands are prohibited.

However, when write cycle is in execution, no interruption can be made.

Product number	WRSR	WRITE
BR25L010-W	Prohibition possible	Prohibition possible
BR25L020-W		
BR25L040-W		
BR25L080-W	Prohibition possible but WPEN bit "1"	Prohibition impossible
BR25L160-W		
BR25L320-W		
BR25L640-W		

○  $\bar{H}OLD$  pin

By  $\bar{H}OLD$  pin, data transfer can be interrupted. When SCK = "1", by making  $\bar{H}OLD$  from "1" into "0", data transfer to EEPROM is interrupted. When SCK = "0", by making  $\bar{H}OLD$  from "0" into "1", data transfer is restarted.

● Command mode

Command		Contents	Ope code					
			BR25L010-W BR25L020-W		BR25L040-W		BR25L080-W BR25L160-W BR25L320-W BR25L640-W	
WREN	Write enable	Write enable command	0000	* 110	0000	* 110	0000	0110
WRDI	Write disable	Write disable command	0000	* 100	0000	* 100	0000	0100
READ	Read	Read command	0000	* 011	0000	A8011	0000	0011
WRITE	Write	Write command	0000	* 010	0000	A8010	0000	0010
RDSR	Read status register	Status register read command	0000	* 101	0000	* 101	0000	0101
WRSR	Write status register	Status register write command	0000	* 001	0000	* 001	0000	0001

● Timing chart

1. Write enable (WREN) / disable (WRDI) cycle

1.WREN (WRITE ENABLE) : Write enable

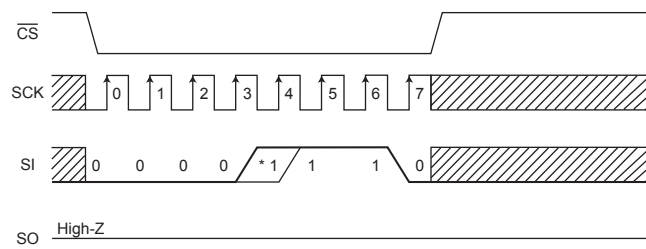

Fig. 35 Write enable command \*1 BR25L010/020/040-W=Don't care  
BR25L080/160/320/640-W="0" input

1.WRDI (WRITE DISABLE) : Write disable

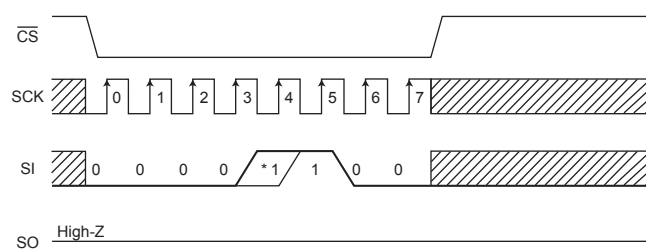

Fig. 36 Write disable \*1 BR25L010/020/040-W=Don't care  
BR25L080/160/320/640-W="0" input

○ This IC has write enable status and write disable status. It is set to write enable status by write enable command, and it is set to write disable status by write disable command. As for these commands, set  $\overline{CS}$  LOW, and then input the respective ope codes. The respective commands accept command at the 7-th clock rise. Even with input over 7 clocks, command becomes valid.

When to carry out write and write status register command, it is necessary to set write enable status by the write enable command. If write or write status register command is input in the write disable status, commands are cancelled. And even in the write enable status, once write and write status register command is executed once, it gets in the write disable status. After power on, this IC is in write disable status.

## 2. Read command (READ)

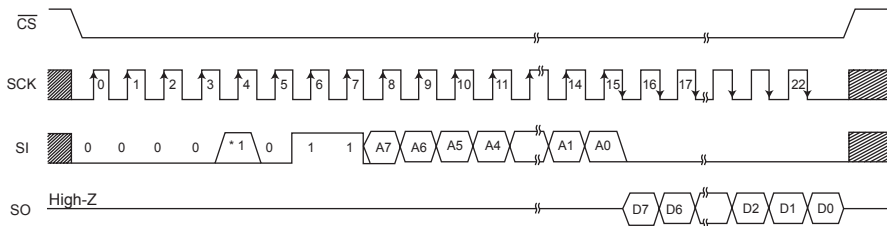

Fig. 37 Read command (BR25L010/020/040-W) \* 1 BR25L010/020-W=Don't care  
BR25L040-W=A8

Product number	Address length
BR25L010-W	A6-A0
BR25L020-W	A7-A0
BR25L040-W	A8-A0

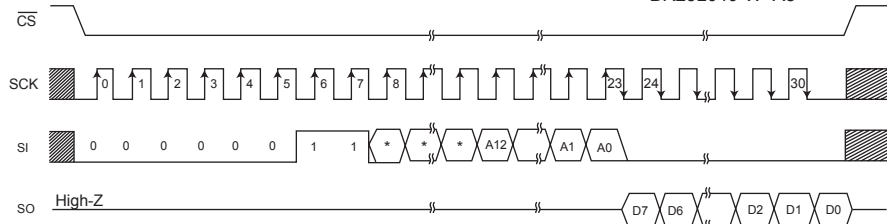

Fig. 38 Read command (BR25L080/160/320/640-W) \* =Don't care

Product number	Address length
BR25L080-W	A9-A0
BR25L160-W	A10-A0
BR25L320-W	A11-A0
BR25L640-W	A12-A0

By read command, data of EEPROM can be read. As for this command, set  $\overline{CS}$  LOW, then input address after read ope code. EEPROM starts data output of the designated address. Data output is started from SCK fall of  $15/23^{-1}$  clock, and from D7 to D0 sequentially. This IC has increment read function. After output of data for 1 byte (8 bits), by continuing input of SCK, data of the next address can be read. Increment read can read all the addresses of EEPROM. After reading data of the most significant address, by continuing increment read, data of the most insignificant address is read.

\* =Don't care \* 1 BR25L010/020/040-W=15 clocks  
BR25L080/160/320/640-W=23 clocks

## 3. Write command (WRITE)

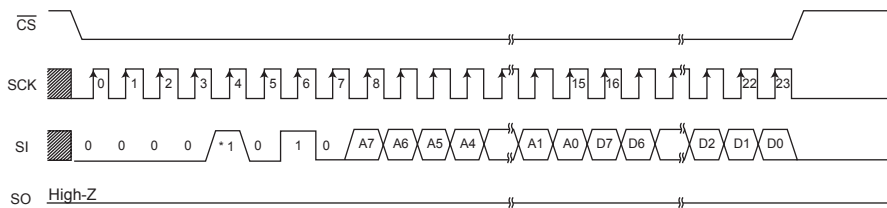

Fig.39 Write command (BR25L010/020/040-W) \* 1 BR25L010/020-W=Don't care  
BR25L040-W=A8

Product number	Address length
BR25L010-W	A6-A0
BR25L020-W	A7-A0
BR25L040-W	A8-A0

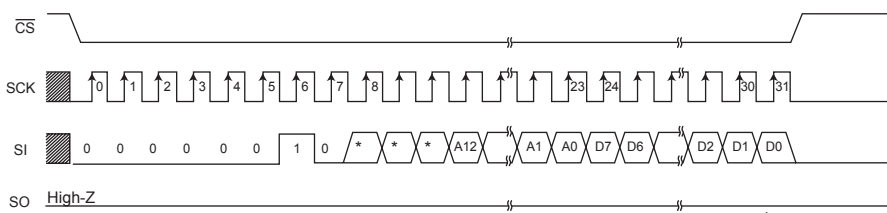

Fig.40 Write command (BR25L080/160/320/640-W) \* =Don't care

Product number	Address length
BR25L080-W	A9-A0
BR25L160-W	A10-A0
BR25L320-W	A11-A0
BR25L640-W	A12-A0

By write command, data of EEPROM can be written. As for this command, set  $\overline{CS}$  LOW, then input address and data after write ope code. Then, by making  $\overline{CS}$  HIGH, the EEPROM starts writing. The write time of EEPROM requires time of  $t_{E/W}$  (Max 5ms). During  $t_{E/W}$ , other than status read command is not accepted. Start  $\overline{CS}$  after taking the last data (D0), and before the next SCL clock starts. At other timing, write command is not executed, and this write command is cancelled. This IC has page write function, and after input of data for 1 byte (8 bits), by continuing data input without starting  $\overline{CS}$ , data up to  $16/32^{-1}$  bytes can be written for one  $t_{E/W}$ . In page write, the insignificant  $4/5^{-2}$  bit of the designated address is incremented internally at every time when data of 1 byte is input, and data is written to respective addresses. When data of the maximum bytes or higher is input, address rolls over, and previously input data is overwritten.

\* 1 BR25L010/020/040-W=16 bytes at maximum  
BR25L080/160/320/640-W=32 bytes at maximum  
\* 2 BR25L010/020/040-W=Insignificant 4 bits  
BR25L080/160/320/640-W=Insignificant 5 bits



#### 4. Status register write / read command

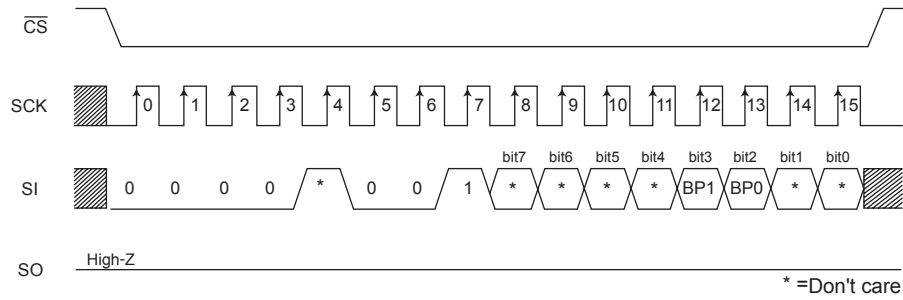

Fig.41 Status register write command (BR25L010/020/040-W)

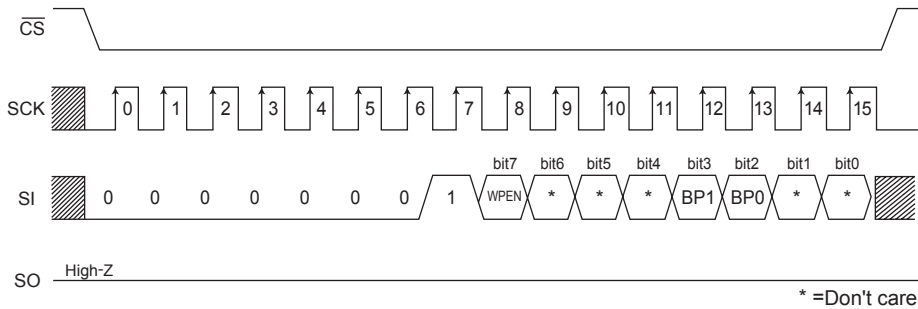

Fig.42 Status register write command (BR25L080/160/320/640-W)

Write status register command can write status register data. The data that can be written by this command are 2 bits \*1, that is, BP1 (bit3) and BP0 (bit2) among 8 bits of status register. By BP1 and BP0, write disable block of EEPROM can be set. As for this command, set  $\overline{CS}$  LOW, and input opcode of write status register, and input data. Then, by making  $\overline{CS}$  HIGH, EEPROM starts writing. Write time requires time of  $tE/W$  as same as write. As for  $\overline{CS}$  rise, start  $\overline{CS}$  after taking the last data bit (bit0), and before the next SCK clock starts. At other timing, command is cancelled. Write disable block is determined by BP1 and BP0, and the block can be selected from 1/4 of memory array, 1/2, and entire memory array. (Refer to the write disable block setting table.) To the write disabled block, write cannot be made, and only read can be made.

\* 3 bits including BR25L080, 160, 320, 640-W WPEN (bit7)

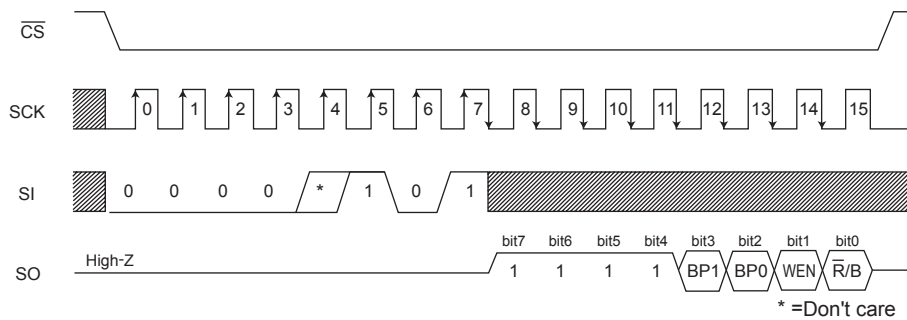

Fig.43 Status register read command (BR25L010/020/040-W)

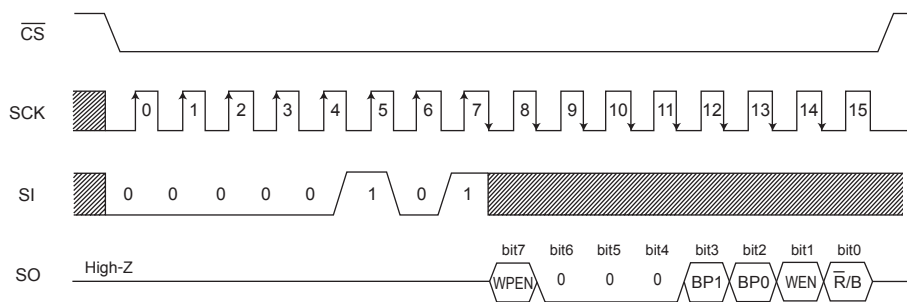

Fig.44 Status register read command (BR25L080/160/320/640-W)

● At standby

○ Current at standby

Set  $\overline{CS}$  "H", and be sure to set SCK, SI,  $\overline{WP}$ ,  $\overline{HOLD}$  input "L" or "H". Do not input intermediate electric potential.

○ Timing

As shown in Fig. 45, at standby, when SCK is "H", even if  $\overline{CS}$  is fallen, SI status is not read at fall edge. SI status is read at SCK rise edge after fall of  $\overline{CS}$ . At standby and at power ON/OFF, set  $\overline{CS}$  "H" status.

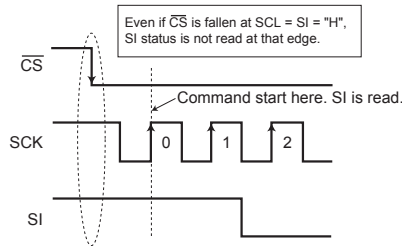

Fig.45 Operating timing

●  $\overline{WP}$  cancel valid area

$\overline{WP}$  is normally fixed to "H" or "L" for use, but when  $\overline{WP}$  is controlled so as to cancel write status register command and write command, pay attention to the following  $\overline{WP}$  valid timing.

While write or write status register command is executed, by setting  $\overline{WP}$  = "L" in cancel valid area, command can be cancelled. The area from command ope code before  $\overline{CS}$  rise at internal automatic write start becomes the cancel valid area. However, once write is started, any input cannot be cancelled.  $\overline{WP}$  input becomes Don't Care, and cancellation becomes invalid.

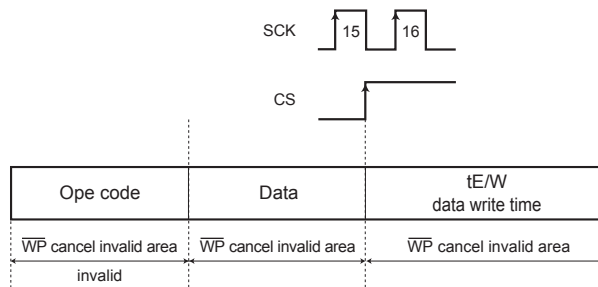

Fig.46  $\overline{WP}$  valid timing (WRSR)

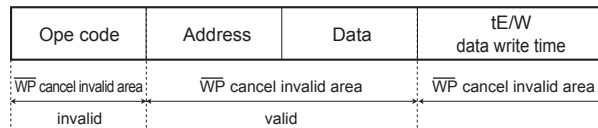

Fig.47  $\overline{WP}$  valid timing (WRITE)

●  $\overline{HOLD}$  pin

By  $\overline{HOLD}$  pin, command communication can be stopped temporarily. (HOLD status) The  $\overline{HOLD}$  pin carries out command communications normally when it is HIGH. To get in HOLD status, at command communication, when SCK = LOW, set the  $\overline{HOLD}$  pin LOW. At HOLD status, SCK and SI become Don't Care, and SO becomes high impedance (High-Z). To release the HOLD status, set the  $\overline{HOLD}$  pin HIGH when SCK = LOW. After that, communication can be restarted from the point before the HOLD status. For example, when HOLD status is made after A5 address input at read, after release of HOLD status, by starting A4 address input, read can be restarted. When in HOLD status, leave  $\overline{CS}$  LOW. When it is set  $\overline{CS}$  = HIGH in HOLD status, the IC is reset, therefore communication after that cannot be restarted.

● Method to cancel each command

○ READ

- Method to cancel : cancel by  $\overline{CS} = "H"$

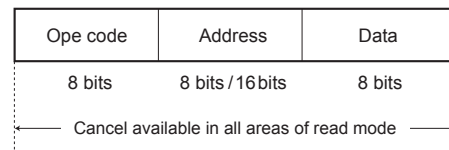

Fig.48 READ cancel valid timing

○ RDSR

- Method to cancel : cancel by  $\overline{CS} = "H"$

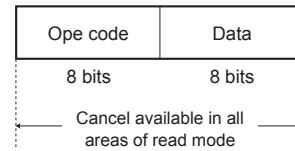

Fig.49 RDSR cancel valid timing

○ WRITE, PAGE WRITE

- a : Ope code, address input area.  
Cancellation is available by  $\overline{CS} = "H"$ .
- b : Data input area (D7 ~ D1 input area)  
Cancellation is available by  $\overline{CS} = "H"$ .
- c : Data input area (D0 area)  
When  $\overline{CS}$  is started, write starts.  
After  $\overline{CS}$  rise, cancellation cannot be made by any means.

- d : tE/W area  
Cancellation is available by  $\overline{CS} = "H"$ . However, when write starts ( $\overline{CS}$  is started) in the area c, cancellation cannot be made by any means. And, by inputting on SCK clock, cancellation cannot be made. In page write mode, there is write enable area at every 8 clocks.

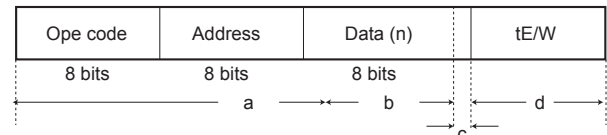
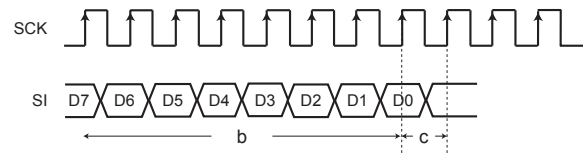

Fig.50 WRITE cancel valid timing



Note 1) If Vcc is made OFF during write execution, designated address data is not guaranteed, therefore write it once again.

Note 2) If  $\overline{CS}$  is started at the same timing as that of the SCK rise, write execution / cancel becomes unstable, therefore, it is recommended to fall in SCK = "L" area. As for SCK rise, assure timing of tCSS / tCSH or higher.

○ WRSR

- a : From ope code to 15 clock rise  
Cancel by  $\overline{CS} = "H"$ .
- b : From 15 clock rise to 16 clock rise (write enable area)  
When  $\overline{CS}$  is started, write starts.  
After  $\overline{CS}$  rise, cancellation cannot be made by any means.
- c : After 16 clock rise  
Cancel by  $\overline{CS} = "H"$ . However, when write starts ( $\overline{CS}$  is started) in the area b, cancellation cannot be made by any means. And, by inputting on SCK clock, cancellation cannot be made.

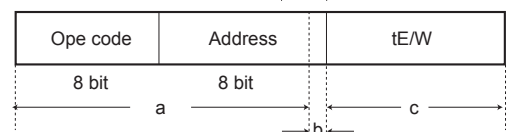
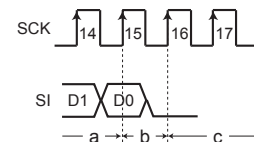

Fig.51 WRSR cancel valid timing

Note 1) If Vcc is made OFF during write execution, designated address data is not guaranteed, therefore write it once again.

Note 2) If  $\overline{CS}$  is started at the same timing as that of the SCK rise, write execution / cancel becomes unstable, therefore, it is recommended to fall in SCK = "L" area. As for SCK rise, assure timing of tCSS/tCSH or higher.

○ WREN/WRDI

- a : From ope code to clock rise, cancel by  $\overline{CS} = "H"$ .
- b : Cancellation is not available when  $\overline{CS}$  is started after 7 clock.

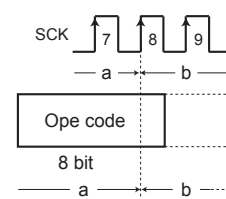

Fig.52 WREN / WRDI cancel valid timing

● High speed operation

In order to realize stable high speed operations, pay attention to the following input / output pin conditions.

○ Input pin pull up, pull down resistance

When to attach pull up, pull down resistance to EEPROM input pin, select an appropriate value for the microcontroller VOL, IOL from VIL characteristics of this IC.

○ Pull up resistance

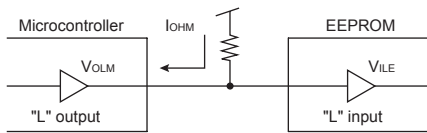

Fig.53 Pull up resistance

$$R_{PU} \geq \frac{V_{CC} - V_{OLM}}{I_{OLM}} \quad \dots \textcircled{1}$$

$$V_{OLM} \leq V_{ILE} \quad \dots \textcircled{2}$$

Example) When  $V_{CC} = 5V$ ,  $V_{ILM} = 1.5V$ ,  $V_{OLM} = 0.4V$ ,  $I_{OLM} = 2mA$ , from the equation ①,

$$R_{PU} \geq \frac{5-0.4}{2 \times 10^{-3}}$$

$$\therefore R_{PU} \geq 2.3[k\Omega]$$

With the value of  $R_{pu}$  to satisfy the above equation,  $V_{OLM}$  becomes 0.4V or higher, and with  $V_{ILE} (= 1.5V)$ , the equation ② is also satisfied.

- $V_{ILM}$  : EEPROM  $V_{IH}$  specifications
- $V_{OLM}$  : Microcontroller  $V_{OL}$  specifications
- $I_{OLM}$  : Microcontroller  $I_{OL}$  specifications

And, in order to prevent malfunction, mistake write at power ON/OFF, be sure to make  $\overline{CS}$  pull up.

○ Pull down resistance

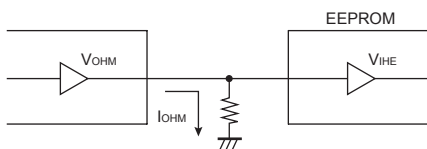

Fig.54 Pull down resistance

$$R_{PD} \geq \frac{V_{OHM}}{I_{OHM}} \quad \dots \textcircled{3}$$

$$V_{OHM} \geq V_{IHE} \quad \dots \textcircled{4}$$

Example) When  $V_{CC} = 5V$ ,  $V_{OHM} = V_{CC} - 0.5V$ ,  $I_{OHM} = 0.4mA$ ,  $V_{IHM} = V_{CC} \times 0.7V$ , from the equation ③,

$$R_{PD} \geq \frac{5-0.5}{0.4 \times 10^{-3}}$$

$$\therefore R_{PD} \geq 11.3[k\Omega]$$

Further, by amplitude  $V_{IHE}$ ,  $V_{ILE}$  of signal input to EEPROM, operation speed changes. By inputting signal of amplitude of  $V_{CC} / GND$  level to input, more stable high speed operations can be realized. On the contrary, when amplitude of  $0.8V_{CC} / 0.2V_{CC}$  is input, operation speed becomes slow.

In order to realize more stable high speed operation, it is recommended to make the values of RPU, RPD as large as possible, and make the amplitude of signal input to EEPROM close to the amplitude of VCC / GND level.  
 (\*1 At this moment, operating timing guaranteed value is guaranteed.)

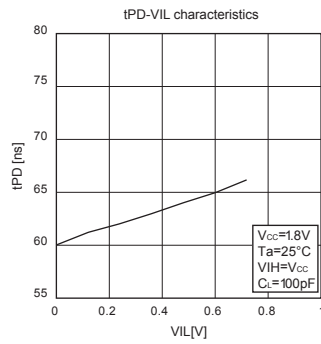

Fig.55 VIL dependency of data output delay time

○ SO load capacity condition

Load capacity of SO output pin affects upon delay characteristic of SO output. (Data output delay time, time from  $\overline{\text{HOLD}}$  to High-Z) In order to make output delay characteristic into higher speed, make SO load capacity small. In concrete, "Do not connect many devices to SO bus", "Make the wire between the controller and EEPROM short", and so forth.

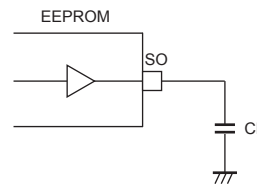
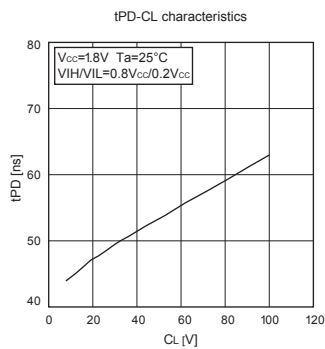

Fig.56 SO load dependency of data output delay time

○ Other cautions

Make the wire length from the microcontroller to EEPROM input signal same length, in order to prevent setup / hold violation to EEPROM, owing to difference of wire length of each input.

- Equivalent circuit
- Output circuit

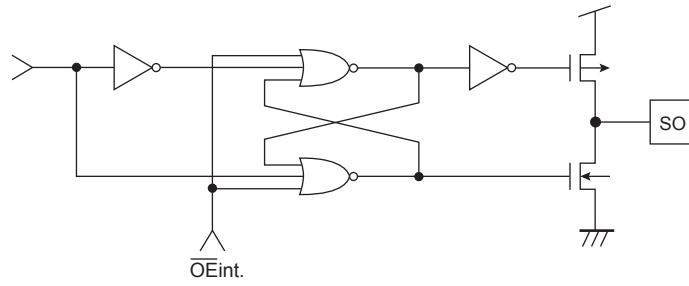

Fig.57 SO output equivalent circuit

- Input circuit

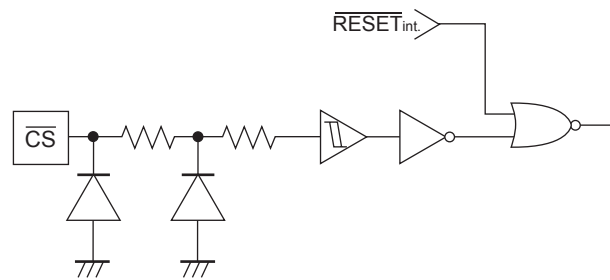

Fig.58  $\overline{CS}$  input equivalent circuit

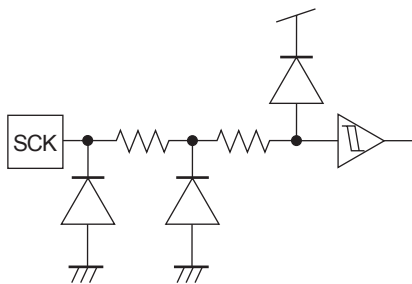

Fig.59 SCK input equivalent circuit

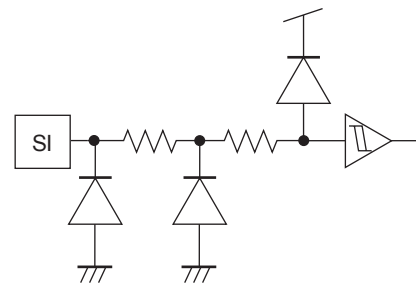

Fig.60 SI input equivalent circuit

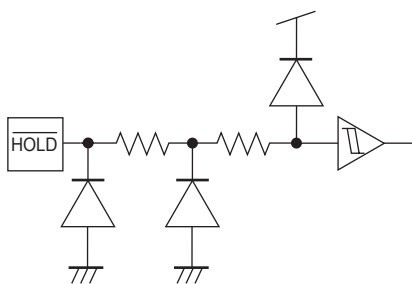

Fig.61  $\overline{HOLD}$  input equivalent circuit

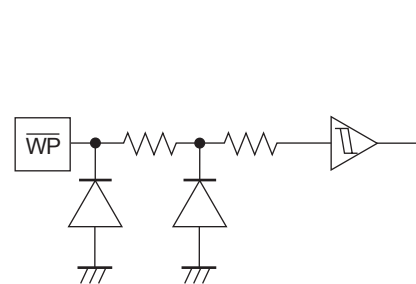

Fig.62  $\overline{WP}$  input equivalent circuit

● Notes on power ON/OFF

○ At power ON/OFF, set  $\overline{CS}$  "H" (=  $V_{CC}$ ).

When  $\overline{CS}$  is "L", this IC gets in input accept status (active). If power is turned on in this status, noises and the likes may cause malfunction, mistake write or so. To prevent these, at power ON, set  $\overline{CS}$  "H". (When  $\overline{CS}$  is in "H" status, all inputs are canceled.)

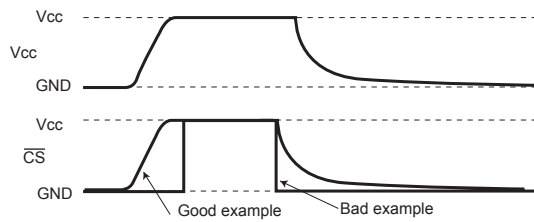

Fig.63  $\overline{CS}$  timing at power ON/OFF

(Good example)  $\overline{CS}$  terminal is pulled up to  $V_{CC}$ .

At power OFF, take 10ms or higher before re supply. If power is turned on without observing this condition, the IC internal circuit may not be reset, which please note.

(Bad example)  $\overline{CS}$  terminal is "L" at power ON/OFF.

In this case,  $\overline{CS}$  always becomes "L" (active status), and EEPROM may have malfunction, mistake write owing to noises and the likes.

Even when  $\overline{CS}$  input is High-Z, the status becomes like this case, which please note.

○ POR circuit

This IC has a POR (Power On Reset) circuit as mistake write countermeasure. After POR action, it gets in write disable status. The POR circuit is valid only when power is ON, and does not work when power is OFF. When power is ON, if the recommended conditions of the following  $t_R$ ,  $t_{OFF}$ , and  $V_{bot}$  are not satisfied, it may become write enable status owing to noises and the likes.

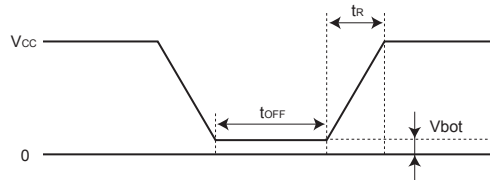

Fig.64 Rise waveform

Recommended conditions of  $t_R$ ,  $t_{OFF}$ ,  $V_{bot}$

$t_R$	$t_{OFF}$	$V_{bot}$
10ms or below	10ms or higher	0.3V or below
100ms or below	10ms or higher	0.2V or below

● Noise countermeasures

○  $V_{CC}$  noise (bypass capacitor)

When noise or surge gets in the power source line, malfunction may occur, therefore, for removing these, it is recommended to attach a bypass capacitor (0.1 $\mu$ F) between IC  $V_{CC}$  and GND. At that moment, attach it as close to IC as possible.

And, it is also recommended to attach a bypass capacitor between board  $V_{CC}$  and GND.

○ SCK noise

When the rise time ( $t_R$ ) of SCK is long, and a certain degree or more of noise exists, malfunction may occur owing to clock bit displacement. To avoid this, a Schmitt trigger circuit is built in SCK input. The hysteresis width of this circuit is set about 0.2V, if noises exist at SCK input, set the noise amplitude 0.2Vp-p or below. And it is recommended to set the rise time ( $t_R$ ) of SCK 100ns or below. In the case when the rise time is 100ns or higher, take sufficient noise countermeasures. Make the clock rise, fall time as small as possible.

○  $\overline{WP}$  noise

During execution of write status register command, if there exist noises on  $\overline{WP}$  pin, mistake in recognition may occur and forcible cancellation may result, which please note. To avoid this, a Schmitt trigger circuit is built in  $\overline{WP}$  input. In the same manner, a Schmitt trigger circuit is built in SI input and HOLD input too.

● Cautions on use

- (1) Described numeric values and data are design representative values, and the values are not guaranteed.
- (2) We believe that application circuit examples are recommendable, however, in actual use, confirm characteristics further sufficiently. In the case of use by changing the fixed number of external parts, make your decision with sufficient margin in consideration of static characteristics and transition characteristics and fluctuations of external parts and our LSI.
- (3) Absolute maximum ratings  
If the absolute maximum ratings such as impressed voltage and operating temperature range and so forth are exceeded, LSI may be destructed. Do not impress voltage and temperature exceeding the absolute maximum ratings. In the case of fear exceeding the absolute maximum ratings, take physical safety countermeasures such as fuses, and see to it that conditions exceeding the absolute maximum ratings should not be impressed to LSI.
- (4) GND electric potential  
Set the voltage of GND terminal lowest at any action condition. Make sure that each terminal voltage is lower than that of GND terminal.
- (5) Heat design  
In consideration of permissible dissipation in actual use condition, carry out heat design with sufficient margin.
- (6) Terminal to terminal short circuit and wrong packaging  
When to package LSI onto a board, pay sufficient attention to LSI direction and displacement. Wrong packaging may destruct LSI. And in the case of short circuit between LSI terminals and terminals and power source, terminal and GND owing to foreign matter, LSI may be destructed.
- (7) Use in a strong electromagnetic field may cause malfunction, therefore, evaluate design sufficiently.

● Selection of order type

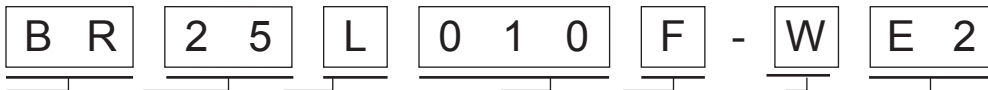

Rohm type name: B R  
 BUS type: 25:SPI  
 Operating temperature: L: -40°C~+85°C, H: -40°C~+125°C  
 Capacity: 010= 1K, 020= 2K, 040= 4K, 080= 8K, 160= 16K, 320= 32K, 640= 64K  
 Package type: F: SOP8, FJ: SOP-J8, FV: SSOP-B8, FVT: TSSOP-B8, FVM: MSOP8, FVJ: TSSOP-B8J  
 Double cell: -  
 Package specifications: E2: reel shape emboss taping, TR: reel shape emboss taping (MSOP8 package only)

● Package specifications

SOP8/SOP-J8/SSOP-B8/TSSOP-B8/TSSOP-B8J

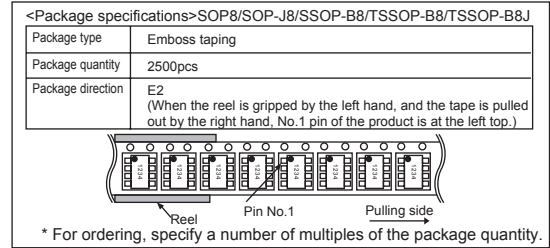
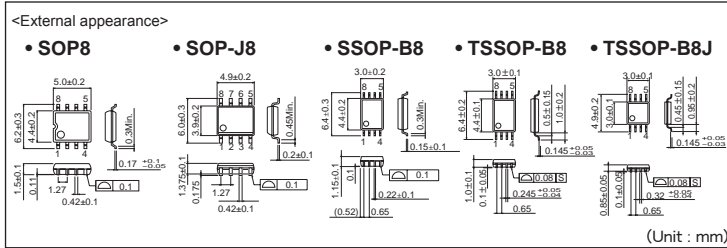

MSOP8

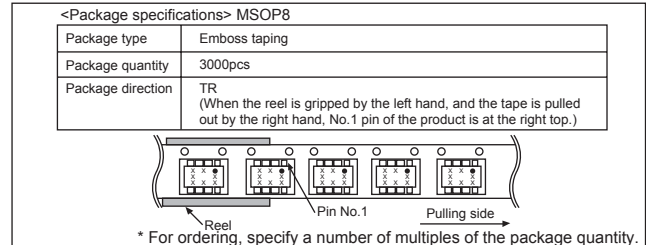
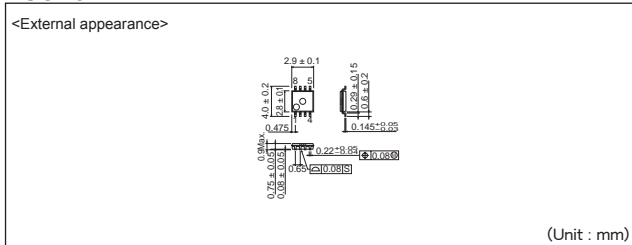

- The contents described herein are correct as of October, 2005
- The contents described herein are subject to change without notice. For updates of the latest information, please contact and confirm with ROHM CO.,LTD.
- Any part of this application note must not be duplicated or copied without our permission.
- Application circuit diagrams and circuit constants contained herein are shown as examples of standard use and operation. Please pay careful attention to the peripheral conditions when designing circuits and deciding upon circuit constants in the set.
- Any data, including, but not limited to application circuit diagrams and information, described herein are intended only as illustrations of such devices and not as the specifications for such devices. ROHM CO.,LTD. disclaims any warranty that any use of such devices shall be free from infringement of any third party's intellectual property rights or other proprietary rights, and further, assumes no liability of whatsoever nature in the event of any such infringement, or arising from or connected with or related to the use of such devices.
- Upon the sale of any such devices, other than for buyer's right to use such devices itself, resell or otherwise dispose of the same, implied right or license to practice or commercially exploit any intellectual property rights or other proprietary rights owned or controlled by ROHM CO., LTD. is granted to any such buyer.
- The products described herein utilize silicon as the main material.
- The products described herein are not designed to be X ray proof.

The products listed in this catalog are designed to be used with ordinary electronic equipment or devices (such as audio visual equipment, office-automation equipment, communications devices, electrical appliances and electronic toys). Should you intend to use these products with equipment or devices which require an extremely high level of reliability and the malfunction of which would directly endanger human life (such as medical instruments, transportation equipment, aerospace machinery, nuclear-reactor controllers, fuel controllers and other safety devices), please be sure to consult with our sales representative in advance.

Excellence in Electronics



ROHM CO., LTD.

21, Saiin Mizosaki-cho, Ukyo-ku, Kyoto 615-8585, Japan  
 TEL: (075)311-2121 FAX: (075)315-0172  
 URL: <http://www.rohm.com>

Published by

Application Engineering Group

Contact us for further information about the products.

Atlanta U.S.A. / ROHM ELECTRONICS ATLANTA SALES OFFICE

(DIVISION OF ROHM ELE.U.S.A.,LLC)

TEL: +1(770)754-8372 FAX: +1(770)754-0691

Dallas U.S.A. / ROHM ELECTRONICS DALLAS SALES OFFICE

(DIVISION OF ROHM ELE.U.S.A.,LLC)

TEL: +1(972)312-8818 FAX: +1(972)312-0330

San Diego U.S.A. / ROHM ELECTRONICS SAN DIEGO SALES OFFICE

(DIVISION OF ROHM ELE.U.S.A.,LLC)

TEL: +1(858)625-3630 FAX: +1(858)625-3670

Germany / ROHM ELECTRONICS GMBH (GERMANY)

TEL: +49(2154)9210 FAX: +49(2154)921400

United Kingdom / ROHM ELECTRONICS GMBH (UK)

TEL: +44(0)1908-306700 FAX: +44(0)1908-235788

France / ROHM ELECTRONICS GMBH (FRANCE)

TEL: +33(0)1 56 97 30 60 FAX: +33(0)1 56 97 30 80

Hong Kong China / ROHM ELECTRONICS (H.K.) CO., LTD.

TEL: +852(2)7406262 FAX: +852(2)375-8971

Shanghai China / ROHM ELECTRONICS (SHANGHAI) CO., LTD.

TEL: +86(21)6279-2727 FAX: +86(21)6247-2066

Dalian China / ROHM ELECTRONICS TRADING (DALIAN) CO., LTD.

TEL: +86(411)8230-6549 FAX: +86(411)8230-6537

Beijing China / BEIJING REPRESENTATIVE OFFICE

TEL: +86(10)8525-2483 FAX: +86(10)8525-2489

Taiwan / ROHM ELECTRONICS TAIWAN CO., LTD.

TEL: +886(2)2500-6956 FAX: +886(2)2503-2869

Korea / ROHM ELECTRONICS KOREA CORPORATION

TEL: +82(2)8182-7000 FAX: +82(2)8182-7115

Singapore / ROHM ELECTRONICS ASIA PTE. LTD. (RES/REI)

TEL: +65-6332-2322 FAX: +65-6332-6662

Malaysia / ROHM ELECTRONICS (MALAYSIA) SDN. BHD.

TEL: +60(3)7958-8355 FAX: +60(3)7958-8377

Philippines / ROHM ELECTRONICS (PHILIPPINES) SALES CORPORATION

TEL: +63(2)807-8872 FAX: +63(2)809-1422

Thailand / ROHM ELECTRONICS (THAILAND) CO., LTD.

TEL: +66(2)254-4830 FAX: +66(2)256-6334



### Notes

- No technical content pages of this document may be reproduced in any form or transmitted by any means without prior permission of ROHM CO.,LTD.
- The contents described herein are subject to change without notice. The specifications for the product described in this document are for reference only. Upon actual use, therefore, please request that specifications to be separately delivered.
- Application circuit diagrams and circuit constants contained herein are shown as examples of standard use and operation. Please pay careful attention to the peripheral conditions when designing circuits and deciding upon circuit constants in the set.
- Any data, including, but not limited to application circuit diagrams information, described herein are intended only as illustrations of such devices and not as the specifications for such devices. ROHM CO.,LTD. disclaims any warranty that any use of such devices shall be free from infringement of any third party's intellectual property rights or other proprietary rights, and further, assumes no liability of whatsoever nature in the event of any such infringement, or arising from or connected with or related to the use of such devices.
- Upon the sale of any such devices, other than for buyer's right to use such devices itself, resell or otherwise dispose of the same, no express or implied right or license to practice or commercially exploit any intellectual property rights or other proprietary rights owned or controlled by
- ROHM CO., LTD. is granted to any such buyer.
- Products listed in this document are no antiradiation design.

The products listed in this document are designed to be used with ordinary electronic equipment or devices (such as audio visual equipment, office-automation equipment, communications devices, electrical appliances and electronic toys).

Should you intend to use these products with equipment or devices which require an extremely high level of reliability and the malfunction of which would directly endanger human life (such as medical instruments, transportation equipment, aerospace machinery, nuclear-reactor controllers, fuel controllers and other safety devices), please be sure to consult with our sales representative in advance.

It is our top priority to supply products with the utmost quality and reliability. However, there is always a chance of failure due to unexpected factors. Therefore, please take into account the derating characteristics and allow for sufficient safety features, such as extra margin, anti-flammability, and fail-safe measures when designing in order to prevent possible accidents that may result in bodily harm or fire caused by component failure. ROHM cannot be held responsible for any damages arising from the use of the products under conditions out of the range of the specifications or due to non-compliance with the NOTES specified in this catalog.

Thank you for your accessing to ROHM product informations.

More detail product informations and catalogs are available, please contact your nearest sales office.

**ROHM** Customer Support System

THE AMERICAS / EUROPE / ASIA / JAPAN

[www.rohm.com](http://www.rohm.com)

Contact us : [webmaster@rohm.co.jp](mailto:webmaster@rohm.co.jp)