

A2A

High-performance Pushbutton Switch with Built-in Subminiature Basic Switch

- Wide selection of pushbutton colors and types.
- Using a Basic Switch enables greater reliability.



 Be sure to read *Safety Precautions for All Pushbutton Switches* and *Safety Precautions* on page 2.

Ordering Information

Pushbutton color	Blue	Black	Green	Red	White	Yellow
Model	A2A-4A	A2A-4B	A2A-4G	A2A-4R	A2A-4W	A2A-4Y

Note: The face nut, lock washer, and operation unit are shipped separately from the body of the Switch. The A2A has solder terminals, SPDT contacts, and momentary operation.

Specifications

Characteristics

Rating	5 A, 125 V (resistive load) 3 A, 250 V (resistive load)
Inrush current	NC: 20 A max. NO: 10 A max.
Contact resistance	50 mΩ max. (initial value)
Dielectric strength	Between terminals of same polarity
	Between current-carrying metal part and ground, and between each terminal and non-current-carrying metal part
Durability	Mechanical
	Electrical
Ambient operating temperature	-25 to 80°C (with no icing or condensation)
Ambient operating humidity	45% to 85%RH
Degree of protection	IP00
Electric shock protection class	Class II
PTI (proof tracking index)	175
Pollution degree	3 (IEC 947-5-1)

Note: The rated values are from testing conducted under the following conditions:

- 1) Ambient temperature: 20 ± 2°C
- 2) Ambient humidity: 65% ± 5%RH
- 3) Operating frequency: 20 operations/minute

Contact Form

Name	Contact form
Double-throw contacts	

Operating Characteristics

Operating Characteristics	Model	A2A
Operating force (OF), max.		1.47 N
Releasing force (RF), min.		0.10 N
Pretravel (PT), max.		0.8 mm
Total travel (TT), max.		1.4 mm

- A D2S-5 is used for the built-in switch.

Dimensions

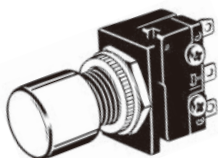

- Note: 1. The Operation Unit can be inserted and removed.
 2. Unless specified, a tolerance of ± 0.8 mm applies for all dimensions.

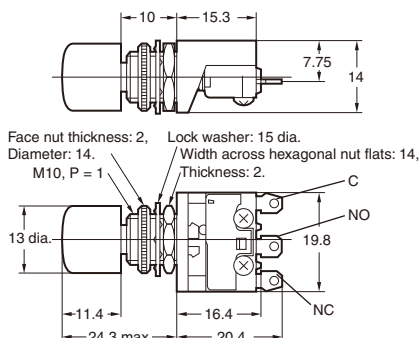

Panel Cutouts



Note: Use a mounting panel thickness of 1 to 4 mm.

Safety Precautions

Refer to **Safety Precautions for All Pushbutton Switches.**

Precautions for Correct Use

- Twist the conductors through the terminal holes before soldering.
- To perform soldering on solder terminals, use a soldering iron with a capacity of 60 W maximum and complete soldering within 5 seconds. Wait for one minute after soldering before exerting any external force on the solder.
 The Switch does not have a ground terminal.
- Do not perform wiring while power is being supplied to the Switch.
 Do not touch the terminals or other charged parts of the Switch while power is being supplied. Doing so may result in electric shock.
- After wiring the Switch, make sure that there is a suitable isolation distance.

Mounting the Operation Unit	Panel Mounting
<ul style="list-style-type: none"> • The Operation Unit can be inserted and removed. • Mounting can be performed by inserting the slit of the Operation Unit into the mounting screw of the Switch. • Mounting force: 39.2 N max. • Removing strength: 24.5 N min. 	<p>Tighten the hexagonal nut while securing the Switch by holding it with your fingers. Tighten the hexagonal nut with a torque of 0.49 to 0.98 N·m.</p>

Safety Precautions for All Pushbutton Switches

For the individual precautions for a Switch, refer to the *Safety Precautions* in the section for that Switch.

WARNING

Do not perform wiring with power supplied to the Switch. Do not touch the terminals or other charged parts of the Switch while power is being supplied. Doing so may result in electric shock.



Caution

Do not apply a voltage between the incandescent lamp and the terminal that is greater than the rated voltage. Doing so may damage the lamp or LED and cause the Operation Unit to pop out.



Always turn OFF the power and wait for 10 minutes before replacing the incandescent lamp. If the lamp is replaced immediately after the power is turned OFF, the remaining heat may cause burns.



Precautions for Correct Use

For details, refer to the *Precautions for Correct Use* in the *Technical Guide for Pushbutton Switches*.

Technical Guide for Pushbutton Switches

Precautions for Correct Use of Pushbutton Switches

●For the individual precautions for a Switch, refer to the precautions in the section for that Switch.

Electrical Characteristics

1. Operating Load

- The switching load capacity of the Switch greatly varies between AC and DC. Always be sure to apply the rated load. The control capacity will drastically drop if it is a DC load. This is because a DC load has no current zero-cross point, unlike an AC load. Therefore, if an arc is generated, it may continue for a comparatively long time. Furthermore, the current direction is always the same, which results in a contact relocation phenomena whereby the contacts easily stick to each other and do not separate when the surfaces of the contacts are uneven.
- Some types of load have a great difference between normal current and inrush current. Make sure that the inrush current is within the permissible value. The greater the inrush current in the closed circuit is, the greater the contact abrasion or shift will be. Consequently, contact weld, contact separation failures, or insulation failures may result. Furthermore, the Switch may be broken or damaged.
- If the load is inductive, counter-electromotive voltage will be generated. The higher the voltage is, the higher the generated energy will be, which will increase the abrasion of the contacts and contact relocation phenomena. Be sure to use the Switch within the rated conditions.

Inrush Current

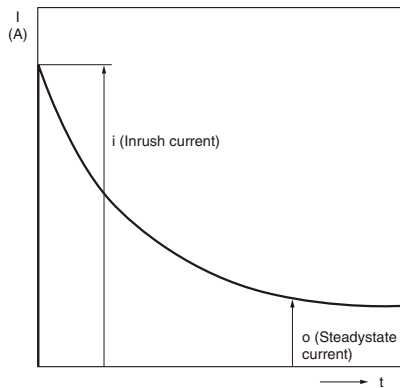

- Approximate control capacities are given in ratings tables, but these alone are insufficient to guarantee correct operation. For special types of load, with unusual switching voltage or current waveforms, test whether correct operation is possible with the actual load before application.
- When switching for microloads (voltage or current), use a Switch with microload specifications. The reliability of silver-plated contacts, which are used in Switches for standard loads, will be insufficient for microloads.
- When switching microloads or very high loads that are beyond the switching capacity of the Switch, connect a relay suitable for the load.

Type of Load vs. Inrush Current

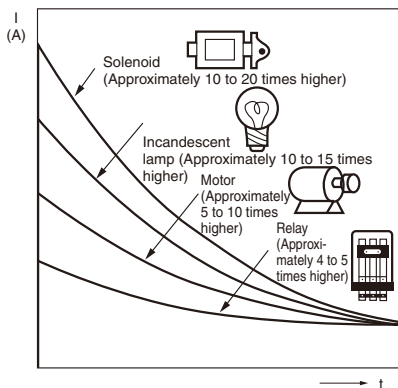

All the performance ratings given are for operation under the following conditions unless otherwise specified.

- Inductive load: A minimum power factor of 0.4 (AC) and a maximum time constant of 7 ms (DC)
- Lamp load: An inrush current 10 times higher than the steady-state current
- Motor load: An inrush current 6 times higher than the steady-state current

Note: Inductive loads can cause problems especially in DC circuitry. Therefore, it is essential to know the time constants (L/R) of the load.

2. Load Connections

Do not connect a single Switch to two power supplies that are different in polarity or type.

Connection of Different Polarities

The power supply may short-circuit if the loads are connected in the way shown in the "incorrect" example below.

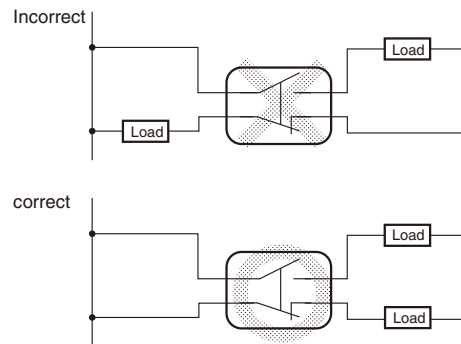

Connect the load to the same polarity.

Even in the "correct" example, note that the insulation performance of the switch may deteriorate and the switch life may be shortened because loads are connected to both contacts.

Connection of Different Power Supplies

The DC and AC power may be mixed for the circuit shown below.

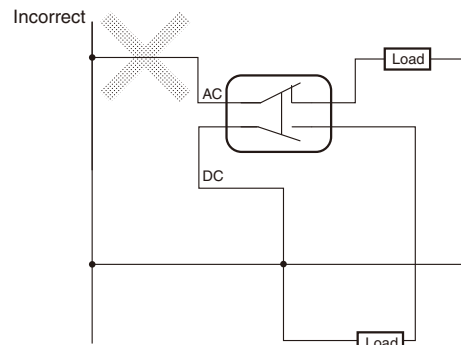

Do not design a circuit where voltage is imposed between contacts, otherwise contact weld may result.

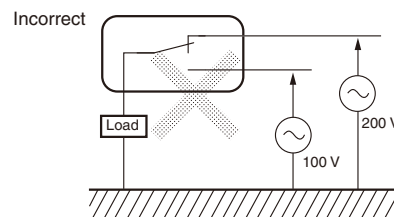

Technical Guide for Pushbutton Switches

3. Contact Protective Circuit

Apply a contact protective circuit to extend the contact life, prevent noise, and suppress the generation of carbide or nitric acid. Be sure to apply the contact protective circuit correctly, otherwise an adverse effect may occur. The following provides typical examples of contact protective circuits. If the Limit Switch is used in an excessively humid

location for switching a load that easily generates arcs, such as an inductive load, the arcs may generate NO_x, which will change into HNO₃ if it reacts with moisture. Consequently, the internal metal parts may corrode and the Limit Switch may fail. Be sure to select the ideal contact preventive circuit from the following.

Typical Examples of Contact Protective Circuits

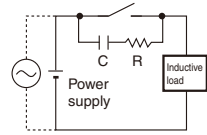
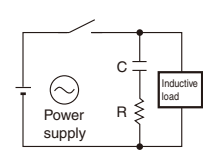
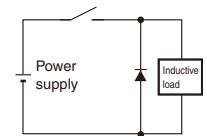
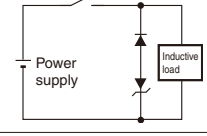
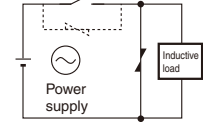
Circuit example	Applicable current		Feature and details	Element selection
	AC	DC		
	*	Yes	*When AC is switched, the load impedance must be lower than the CR impedance.	C: 1 to 0.5 μF × switching current (A) R: 0.5 to 1 Ω × switching voltage (V) The values may change according to the characteristics of the load. The capacitor suppresses the spark discharge of current when the contacts are open. The resistor limits the inrush current when the contacts are closed again. Consider the roles of the capacitor and resistor and determine ideal capacitance and resistance values through testing. Basically, use a capacitor with a dielectric strength between 200 and 300 V. When AC is switched, make sure that the capacitor has no polarity.
		Yes	Yes	
	No	Yes	Energy stored in the coil is changed into current by the diode connected in parallel to the load. Then the current flowing to the coil is consumed and Joule heat is generated by the resistance of the inductive load. The reset time delay with this method is longer than that in the CR method.	The diode must withstand a peak inverse voltage 10 times higher than the circuit voltage and a forward current as high or higher than the load current.
	No	Yes	This method will be effective if the reset time delay caused by the diode method is too long.	Use a Zener diode with a Zener voltage that is approximately 1.2 × power supply voltage as, depending on the environment, the load may not operate.
	Yes	Yes	This method makes use of constant-voltage characteristic of the varistor so that no high-voltage is imposed on the contacts. This method causes a reset time delay. Connecting a varistor in parallel to the load is effective when the supply voltage is 24 to 48 V and in parallel to the contacts when the supply voltage is 100 to 200 V.	---

Do not apply contact protective circuits as shown below.

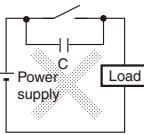
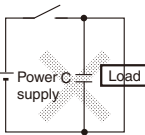
	<p>This circuit effectively suppresses arcs when the contacts are OFF. The capacitor will be charged, however, when the contacts are OFF. Consequently, when the contacts are ON again, short-circuited current from the capacitance may cause contact weld.</p>		<p>This circuit effectively suppresses arcs when the contacts are OFF. When the contacts are ON again, however, charge current will flow to the capacitor, which may result in contact weld.</p>
---	--	---	--

Switching a DC inductive load is usually more difficult than switching a resistive load. By using an appropriate contact protective circuit, however, switching a DC inductive load will be as easy as switching a resistive load.

4. Switching

- Do not use the Switch for loads that exceed the rated switching capacity or other contact ratings. Doing so may result in contact weld, contact separation failures, or insulation failures. Furthermore, the Switch may be broken or damaged.
- Do not touch the charged switch terminals while power is supplied, otherwise an electric shock may be received.
- The life of the Switch varies greatly with switching conditions. Before using the Switch, be sure to test the Switch under actual conditions. Make sure that the number of switching operations is within the permissible range. If a deteriorated Switch is used continuously, insulation failures, contact weld, contact failures, switch damage, or switch burnout may result.

- Do not apply excessive or incorrect voltages to the Switch or incorrectly wire the terminals. Otherwise, the Switch may not function properly and have an adverse effect on external circuitry. Furthermore, the Switch itself may become damaged or burnt.
- Do not use the Switch in locations where flammable or explosive gases are present. Otherwise switching arcs or heat radiation may cause a fire or explosion.
- Do not drop or disassemble the Switch, otherwise it may not be capable of full performance. Furthermore, it may be broken or burnt.

Mechanical Conditions

Operating Force and Operating Method

- Fingertip operation is an important feature of Pushbutton Switches. In terms of Switch operation, Pushbutton Switches differ greatly from detection switches such as Microswitches. Operating the Switch using a hard object (e.g., metal), or with a large or sudden force, may deform or damage the Switch, resulting in faulty or rough operation, or shortening of the Switch life. The strength varies with the size and construction of the Switch. Use the appropriate Switch for the application after confirming the operating method and operating force with this catalog.

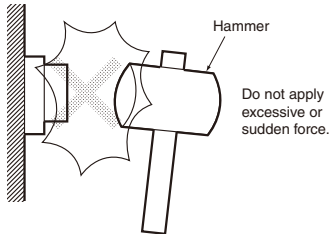

- The pushbutton surface is composed of resin. Therefore, do not attempt to operate the pushbutton using a sharp object, such as a screwdriver or a pair of tweezers. Doing so may damage or deform the pushbutton surface and result in faulty operation.

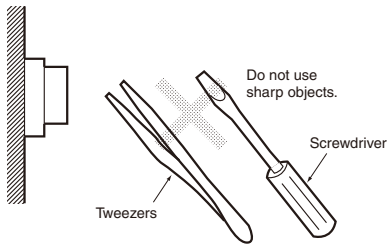

Mounting

- Switches can be broadly divided into two categories according to mounting method: panel-mounting models and PCB-mounting models. Use the appropriate model for the mounting method required. Basically, panel-mounting Switches can withstand a greater operating force than PCB-mounting Switches. If, however, the panel thickness or the panel-cutout dimensions are not suitable for the Switch, it may not be able to withstand the normal operating force. With continuous mounting in particular, select a panel of a thickness that is easily sufficient to withstand the total operating force.
- Panel-mounting Switches can be divided into two categories according to the mounting method: snap-in mounting models and screw-mounting models. Snap-in mounting Switches are held in place with the elasticity of resin or a metal leaf spring. Do not attempt to modify the spring after mounting. Doing so may result in faulty operation or damage the mounting structure. Mount screw-mounting models using the screws and nuts provided (or individually specified). Tighten the screws to the specified torque. Mounting with different screws or nuts, or tightening beyond the specified torque may result in distortion of the inside of the case or damage to the screw section.

Snap-in Mounting

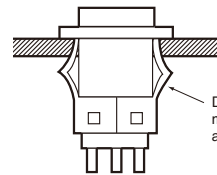

Screw Mounting

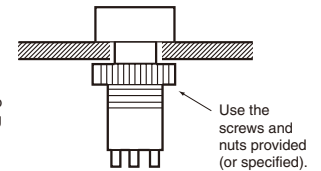

- Subjecting the Switch to severe vibrations or shock may result in faulty operation or damage. Also, many of the Switches are composed of resin so contact with sharp objects may result in damage to the surface. This kind of damage may spoil the appearance of the Switch or result in faulty operation. Do not throw or drop the Switch.

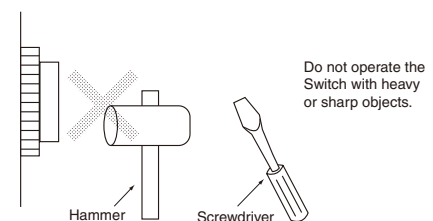
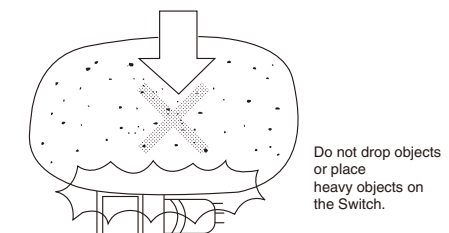
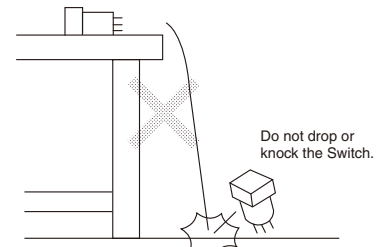

Technical Guide for Pushbutton Switches

Mounting Precautions

Wiring

- Perform wiring so that the lead wires will not be caught on other objects as this will cause stress on the Switch terminals. Wire the Switch so that there is slack in the lead wires and fix lead wires at intermediate points. If the panel to which the Switch is mounted needs to be opened and closed for maintenance purposes, perform wiring so that the opening and closing of the panel will not interfere with the wiring.

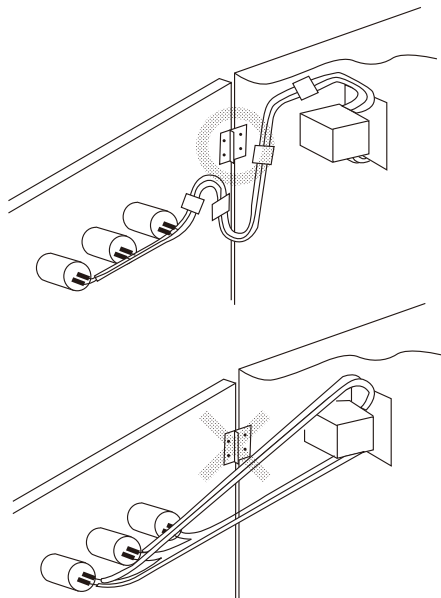

- With miniature Switches, the gap between the terminals is very narrow. Use protective or heat-absorbing tubes to prevent burning of the wire sheath or shorting.

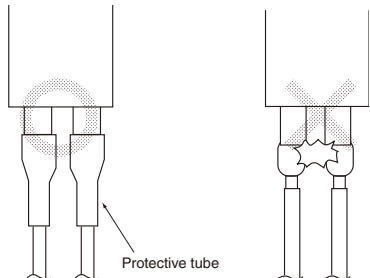

Soldering

- There are two methods for soldering the Switch: hand soldering and automatic soldering. In addition, automatic soldering itself can be divided into two types : dip soldering and reflow soldering. Use the soldering method appropriate for the mounting method.

Typical Soldering Example

Method		Soldering device	Application
Hand soldering		Soldering iron	Small quantities Different materials Lead wire terminals
Automatic soldering	Dip soldering	Jet soldering bath Dip soldering bath	Large quantities of discrete terminals
	Reflow soldering	Infrared reflow (IR) soldering bath Vapor-phase (VPS) reflow soldering bath	Large quantities of miniature SMD terminals

- Do not use soldering flux that contains chlorine. Doing so may result in metal corrosion.

- Perform hand soldering using the appropriate soldering iron.

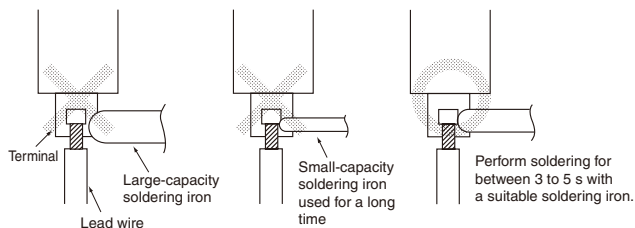

- With the exception of PCB-mounting Switches, when performing hand soldering, hold the Switch so that the terminals point downwards so that flux does not get inside the Switch.

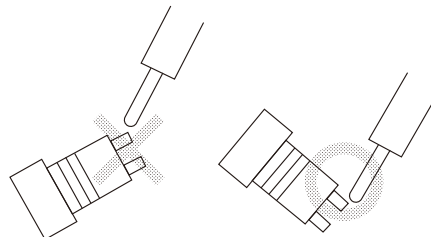

- Leave a gap of at least 1 mm between the soldered parts and the surface of the case so that flux does not get inside the Switch.

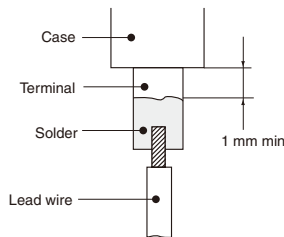

- When applying flux using a brush, use a sponge soaked in flux as shown below. Do not apply more than is necessary. Also, apply the flux with the PCB inclined at an angle of less than 80° so that flux does not flow onto the mounting surface of the Switch.

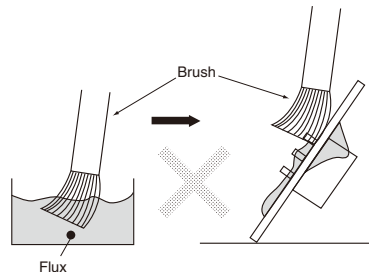
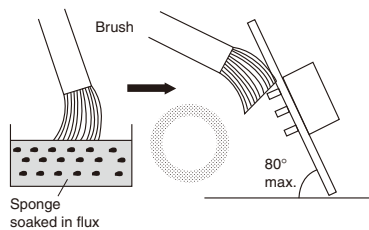

Technical Guide for Pushbutton Switches

- Do not place PCBs that have had flux applied or have been soldered on top of each other. Otherwise, the flux on the PCBs solder surface may stain the upper part of the Switch or even permeate the inside of the Switch and cause contact failure. Be sure to insert a special PCB stocker.

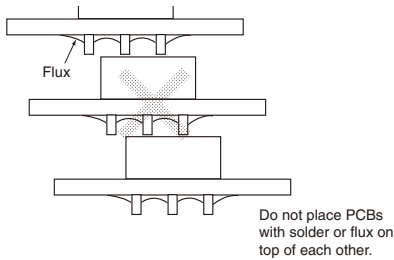

- When performing soldering with a dip soldering bath, ensure that the flux does not reach a higher level than the PCB.

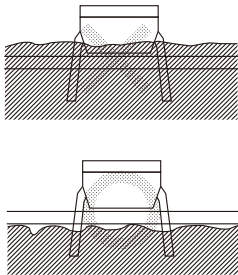

- Flux is especially likely to rise up at the edges of the PCB. If the Switch is mounted near the edge of the PCB, create a gap between the edge by using a split PCB, and insert the PCB in the soldering bath so that the edge that is farthest from the Switch enters the bath first.

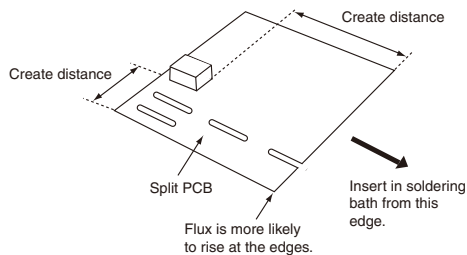

Storage

- When the Switch is left unused or stored for long periods, the ambient conditions can have a great effect on the condition of the Switch. In certain environments, leaving the Switch exposed may result in deterioration (i.e., oxidation, or the creation of an oxide film) of the contacts and terminals, causing the contact resistance to increase, and making it difficult to solder the lead wires. Therefore, store in a well-ventilated room, inside, for example, a non-hygrosopic case, in a location where no corrosive gases are present.

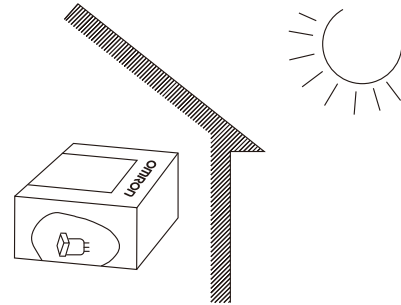

- If the Switch is stored in a location where it will be exposed to direct light, colored resin in the colored plate may fade. Therefore, do not store the Switch in locations where it will be exposed to direct light.

Read and Understand This Catalog

Please read and understand this catalog before purchasing the products. Please consult your OMRON representative if you have any questions or comments.

Warranty and Limitations of Liability

WARRANTY

OMRON's exclusive warranty is that the products are free from defects in materials and workmanship for a period of one year (or other period if specified) from date of sale by OMRON.

OMRON MAKES NO WARRANTY OR REPRESENTATION, EXPRESS OR IMPLIED, REGARDING NON-INFRINGEMENT, MERCHANTABILITY, OR FITNESS FOR PARTICULAR PURPOSE OF THE PRODUCTS. ANY BUYER OR USER ACKNOWLEDGES THAT THE BUYER OR USER ALONE HAS DETERMINED THAT THE PRODUCTS WILL SUITABLY MEET THE REQUIREMENTS OF THEIR INTENDED USE. OMRON DISCLAIMS ALL OTHER WARRANTIES, EXPRESS OR IMPLIED.

LIMITATIONS OF LIABILITY

OMRON SHALL NOT BE RESPONSIBLE FOR SPECIAL, INDIRECT, OR CONSEQUENTIAL DAMAGES, LOSS OF PROFITS, OR COMMERCIAL LOSS IN ANY WAY CONNECTED WITH THE PRODUCTS, WHETHER SUCH CLAIM IS BASED ON CONTRACT, WARRANTY, NEGLIGENCE, OR STRICT LIABILITY.

In no event shall responsibility of OMRON for any act exceed the individual price of the product on which liability is asserted.

IN NO EVENT SHALL OMRON BE RESPONSIBLE FOR WARRANTY, REPAIR, OR OTHER CLAIMS REGARDING THE PRODUCTS UNLESS OMRON'S ANALYSIS CONFIRMS THAT THE PRODUCTS WERE PROPERLY HANDLED, STORED, INSTALLED, AND MAINTAINED AND NOT SUBJECT TO CONTAMINATION, ABUSE, MISUSE, OR INAPPROPRIATE MODIFICATION OR REPAIR.

Application Considerations

SUITABILITY FOR USE

OMRON shall not be responsible for conformity with any standards, codes, or regulations that apply to the combination of products in the customer's application or use of the product.

At the customer's request, OMRON will provide applicable third party certification documents identifying ratings and limitations of use that apply to the products. This information by itself is not sufficient for a complete determination of the suitability of the products in combination with the end product, machine, system, or other application or use.

The following are some examples of applications for which particular attention must be given. This is not intended to be an exhaustive list of all possible uses of the products, nor is it intended to imply that the uses listed may be suitable for the products:

- Outdoor use, uses involving potential chemical contamination or electrical interference, or conditions or uses not described in this catalog.
- Nuclear energy control systems, combustion systems, railroad systems, aviation systems, medical equipment, amusement machines, vehicles, safety equipment, and installations subject to separate industry or government regulations.
- Systems, machines, and equipment that could present a risk to life or property.

Please know and observe all prohibitions of use applicable to the products.

NEVER USE THE PRODUCTS FOR AN APPLICATION INVOLVING SERIOUS RISK TO LIFE OR PROPERTY WITHOUT ENSURING THAT THE SYSTEM AS A WHOLE HAS BEEN DESIGNED TO ADDRESS THE RISKS, AND THAT THE OMRON PRODUCT IS PROPERLY RATED AND INSTALLED FOR THE INTENDED USE WITHIN THE OVERALL EQUIPMENT OR SYSTEM.

Disclaimers

CHANGE IN SPECIFICATIONS

Product specifications and accessories may be changed at any time based on improvements and other reasons.

It is our practice to change model numbers when published ratings or features are changed, or when significant construction changes are made. However, some specifications of the product may be changed without any notice. When in doubt, special model numbers may be assigned to fix or establish key specifications for your application on your request. Please consult with your OMRON representative at any time to confirm actual specifications of purchased product.

DIMENSIONS AND WEIGHTS

Dimensions and weights are nominal and are not to be used for manufacturing purposes, even when tolerances are shown.

ERRORS AND OMISSIONS

The information in this catalog has been carefully checked and is believed to be accurate; however, no responsibility is assumed for clerical, typographical, or proofreading errors, or omissions.

PERFORMANCE DATA

Performance data given in this catalog is provided as a guide for the user in determining suitability and does not constitute a warranty. It may represent the result of OMRON's test conditions, and the users must correlate it to actual application requirements. Actual performance is subject to the OMRON Warranty and Limitations of Liability.

PROGRAMMABLE PRODUCTS

OMRON shall not be responsible for the user's programming of a programmable product, or any consequence thereof.

COPYRIGHT AND COPY PERMISSION

This catalog shall not be copied for sales or promotions without permission.

This catalog is protected by copyright and is intended solely for use in conjunction with the product. Please notify us before copying or reproducing this catalog in any manner, for any other purpose. If copying or transmitting this catalog to another, please copy or transmit it in its entirety.