

PRODUCT NUMBER	PLATING PERFORMANCE LEVEL	APPLICATION	SHROUD TO USE FOR REAR PLUG-UP APPLICATIONS
74978-102ZZZ	TELCORDIA CO	STANDARD	84625-102
74978-102ZZZLF		LEAD FREE	84625-302
74978-502ZZZ	TELCORDIA UE	STANDARD	84625-302
74978-502ZZZLF		LEAD FREE	84625-502

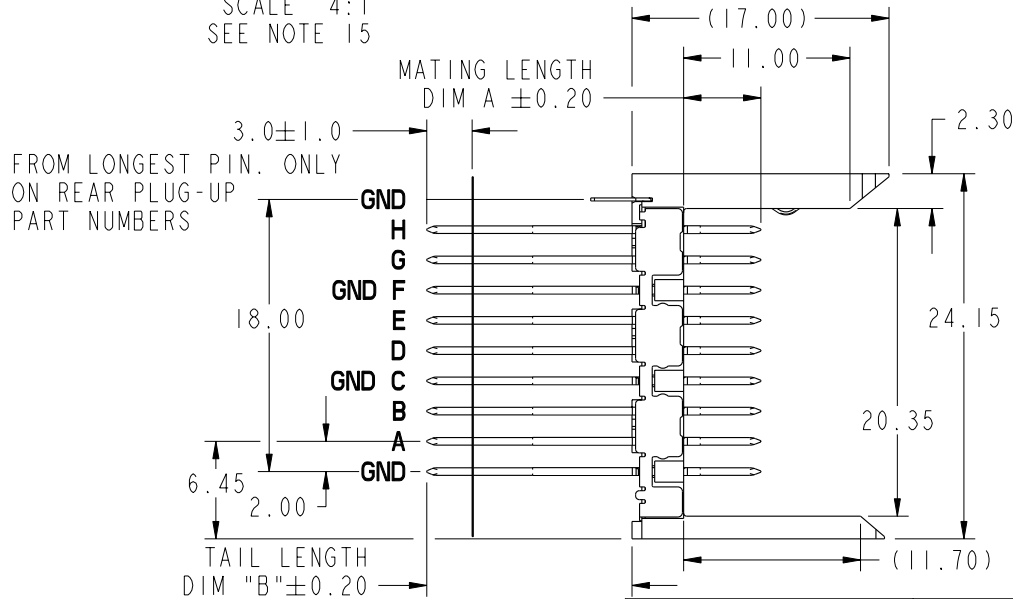

DETAIL A
SCALE 4:1
SEE NOTE 15



SEE DETAIL A

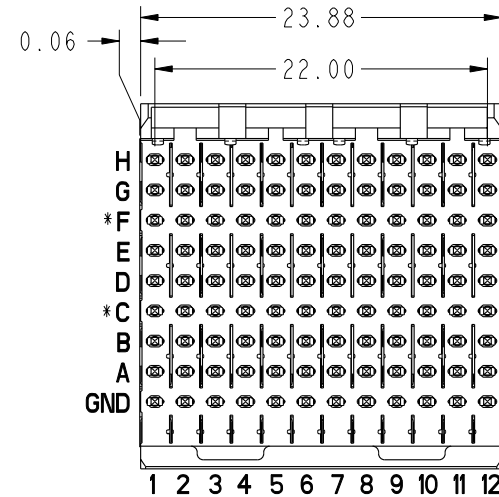
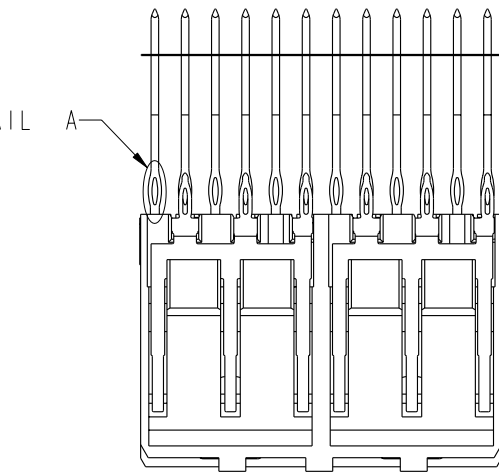

mat'l code SEE NOTE 5				tolerances unless otherwise specified			CUSTOMER	FCj www.fciconnect.com	
ltr	ecm no.	dr	date	linear	0.X ± 0.3	COPY	title		
P	V06-0544	DCH	2006-06-09	linear	0.XX ± 0.13	projection	VERTICAL SIGNAL HDR 8 ROW		
R	V07-0183	DCH	2007-04-20	angles	.XXX ± 0.51		P.F. 96 POS. SPECIAL LOAD EXT.		
S	V08-0010	HTB	2008-01-07	angles	0° $\pm 2°$		product family METRAL 2000 code		
T	V08-0023	LP	2008-1-23	dr	E. KROPER. 2001-01-10	MM	size	dwg no	213
-	-	-	-	enrg	J. VOLSTORF 2001-01-10		A	74978	sheet
M	V03-1156	TAB	2003-11-03	chr	J. VOLSTORF 2001-01-10		scale	1:1	1 of 6
N	V05-0814	VS	2005-09-21	appd	J. VOLSTORF 2001-01-10	cage code 22526			4
sheet index	revision sheet	T	T	T	T	T	T	T	T
		1	2	3	4	5	6		

***ROW C AND F INFORMATION**
ODD NUMBER COLUMNS WITHIN ROW C & F ARE COMMONED TO GROUND INTERNALLY WITHIN THE HOUSING. THE EVEN NUMBER COLUMNS WITHIN ROW C & F ARE NOT. FOR MAXIMUM PERFORMANCE IT IS RECOMMENDED THESE EVEN COLUMNS BE GROUND COMMONED WITHIN PCB. SEE NOTE 14

This document is the property of and embodies CONFIDENTIAL and PROPRIETARY information of FCj. No part of the information shown on this document may be used in any way or disclosed to others without the written consent of FCj. Copyright FCj.

PIN CODE NO.	DIM A MATING LENGTH	DIM B TAIL LENGTH	PCB THICKNESS RANGE ACCOMMODATED BY PIN'S TAIL LENGTH				
			WHEN MATING TO A 74981 METRAL 1000 SERIES RECEPTACLE		WHEN MATING TO A 52066 SERIES METRAL 4000 RECEPTACLE		
			ROWS A,B,C, D,E,F,G & H	GROUND ROW	ROWS:A,B, D,E,G & H	ROW C&F	GROUND ROW
01*	5.00	4.30	1.60 MIN	1.60 MIN	1.60 MIN	1.60 MIN	1.60 MIN
22		12.20	2.95 - 3.80	2.95 - 4.20	2.95 - 3.80	2.95 - 3.80	2.95 - 4.20
30		12.95	2.95 - 4.55	3.25 - 4.95	2.95 - 4.55	2.95 - 4.55	3.25 - 4.95
05		13.70	2.95 - 5.30	4.00 - 5.70	3.30 - 5.30	2.95 - 5.30	4.00 - 5.70
35		14.45	3.05 - 6.05	4.75 - 6.45	4.05 - 6.05	3.05 - 6.05	4.75 - 6.45
48		15.20	3.80 - 6.80	5.50 - 7.20	4.80 - 6.80	3.80 - 6.80	5.50 - 7.20
40		15.70	4.30 - 7.30	6.00 - 7.70	5.30 - 7.30	4.30 - 7.30	6.00 - 7.70
65		16.40	5.00 - 8.00	6.70 - 8.40	6.00 - 8.00	5.00 - 8.00	6.70 - 8.40
09		17.10	5.70 - 8.70	7.40 - 9.10	6.70 - 8.70	5.70 - 8.70	7.40 - 9.10
02*	5.75	4.30	1.60 MIN	1.60 MIN	1.60 MIN	1.60 MIN	1.60 MIN
44		12.20	2.95 - 3.80	2.95 - 4.20	2.95 - 3.80	2.95 - 3.80	2.95 - 4.20
31		12.95	2.95 - 4.55	3.25 - 4.95	2.95 - 4.55	2.95 - 4.55	3.25 - 4.95
06		13.70	2.95 - 5.30	4.00 - 5.70	3.30 - 5.30	2.95 - 5.30	4.00 - 5.70
36		14.45	3.05 - 6.05	4.75 - 6.45	4.05 - 6.05	3.05 - 6.05	4.75 - 6.45
49		15.20	3.80 - 6.80	5.50 - 7.20	4.80 - 6.80	3.80 - 6.80	5.50 - 7.20
25		15.70	4.30 - 7.30	6.00 - 7.70	5.30 - 7.30	4.30 - 7.30	6.00 - 7.70
66		16.40	5.00 - 8.00	6.70 - 8.40	6.00 - 8.00	5.00 - 8.00	6.70 - 8.40
10		17.10	5.70 - 8.70	7.40 - 9.10	6.70 - 8.70	5.70 - 8.70	7.40 - 9.10
03*	6.50	4.30	1.60 MIN	1.60 MIN	1.60 MIN	1.60 MIN	1.60 MIN
45		12.20	2.95 - 3.80	2.95 - 4.20	2.95 - 3.80	2.95 - 3.80	2.95 - 4.20
32		12.95	2.95 - 4.55	3.25 - 4.95	2.95 - 4.55	2.95 - 4.55	3.25 - 4.95
07		13.70	2.95 - 5.30	4.00 - 5.70	3.30 - 5.30	2.95 - 5.30	4.00 - 5.70
37		14.45	3.05 - 6.05	4.75 - 6.45	4.05 - 6.05	3.05 - 6.05	4.75 - 6.45
50		15.20	3.80 - 6.80	5.50 - 7.20	4.80 - 6.80	3.80 - 6.80	5.50 - 7.20
41		15.70	4.30 - 7.30	6.00 - 7.70	5.30 - 7.30	4.30 - 7.30	6.00 - 7.70
24		16.40	5.00 - 8.00	6.70 - 8.40	6.00 - 8.00	5.00 - 8.00	6.70 - 8.40
11		17.10	5.70 - 8.70	7.40 - 9.10	6.70 - 8.70	5.70 - 8.70	7.40 - 9.10



This document is the property of and embodies CONFIDENTIAL and PROPRIETARY information of FCI. No part of the information shown on this document may be used in any way or disclosed to others without the written consent of FCI. Copyright FCI.

* STUB PINS - NO REAR PLUG-UP

** THE GREATEST RANGE OCCURS WHEN THE B DIMENSION OF PIN 'GND' IS ONE SIZE SHORTER THEN THE OTHER PINS.

mat'l code SEE NOTE 5				tolerances unless otherwise specified		CUSTOMER		www.fciconnect.com		
ltr	ecn no.	dr	date	linear	0.X ±0.3	COPY			title VERTICAL SIGNAL HDR 8 ROW P.F. 96 POS. SPECIAL LOAD EXT.	
T					0.XX ±0.13	MM				product family METRAL 2000 code 213 size dwg no 74978 sheet 2
					.XXX ±.051	1:1				
				angles	0° ±2°					
				dr	E. KROPER. 2001-01-10					
				engr	J. VOLSTORF 2001-01-10					
				chr	J. VOLSTORF 2001-01-10					
				appd	J. VOLSTORF 2001-01-10					
sheet index	revision sheet									

PIN CODE NO.	DIM A MATING LENGTH	DIM B TAIL LENGTH	PCB THICKNESS RANGE ACCOMMODATED BY PIN LENGTH				
			WHEN MATING TO A 73981 OR 84688 SERIES RECEPTACLE		WHEN MATING TO A 52057 SERIES METRAL 4000 RECEPTACLE		
			ROWS A,B,C,D,E	GROUND ROW	ROWS:A,B,D,E	ROW C	GROUND ROW
04*	7.25	4.30	1.60 MIN	1.60 MIN	1.60 MIN	1.60 MIN	1.60 MIN
46		12.20	2.95 - 3.80	2.95 - 4.20	2.95 - 3.80	2.95 - 3.80	2.95 - 4.20
33		12.95	2.95 - 4.55	3.25 - 4.95	2.95 - 4.55	2.95 - 4.55	3.25 - 4.95
08		13.70	2.95 - 5.30	4.00 - 5.70	3.30 - 5.30	2.95 - 5.30	4.00 - 5.70
38		14.45	3.05 - 6.05	4.75 - 6.45	4.05 - 6.05	3.05 - 6.05	4.75 - 6.45
51		15.20	3.80 - 6.80	5.50 - 7.20	4.80 - 6.80	3.80 - 6.80	5.50 - 7.20
42		15.70	4.30 - 7.30	6.00 - 7.70	5.30 - 7.30	4.30 - 7.30	6.00 - 7.70
67		16.40	5.00 - 8.00	6.70 - 8.40	6.00 - 8.00	5.00 - 8.00	6.70 - 8.40
12		17.10	5.70 - 8.70	7.40 - 9.10	6.70 - 8.70	5.70 - 8.70	7.40 - 9.10
19*	8.00	4.30	1.60 MIN	1.60 MIN	1.60 MIN	1.60 MIN	1.60 MIN
47		12.20	2.95 - 3.80	2.95 - 4.20	2.95 - 3.80	2.95 - 3.80	2.95 - 4.20
34		12.95	2.95 - 4.55	3.25 - 4.95	2.95 - 4.55	2.95 - 4.55	3.25 - 4.95
20		13.70	2.95 - 5.30	4.00 - 5.70	3.30 - 5.30	2.95 - 5.30	4.00 - 5.70
39		14.45	3.05 - 6.05	4.75 - 6.45	4.05 - 6.05	3.05 - 6.05	4.75 - 6.45
52		15.20	3.80 - 6.80	5.50 - 7.20	4.80 - 6.80	3.80 - 6.80	5.50 - 7.20
43		15.70	4.30 - 7.30	6.00 - 7.70	5.30 - 7.30	4.30 - 7.30	6.00 - 7.70
68		16.40	5.00 - 8.00	6.70 - 8.40	6.00 - 8.00	5.00 - 8.00	6.70 - 8.40
21		17.10	5.70 - 8.70	7.40 - 9.10	6.70 - 8.70	5.70 - 8.70	7.40 - 9.10

A

A



This document is the property of and embodies CONFIDENTIAL and PROPRIETARY information of FCI. No part of the information shown on this document may be used in any way or disclosed to others without the written consent of FCI. Copyright FCI.

B

* STUB PINS - NO REAR PLUG-UP

** THE GREATEST RANGE OCCURS WHEN THE B DIMENSION OF PIN 'GND' IS ONE SIZE SHORTER THEN THE OTHER PINS.

mat'l code SEE NOTE 5				tolerances unless otherwise specified		CUSTOMER	www.fciconnect.com	
ltr	ecn no.	dr	date	linear	0.X ±0.3	COPY	title	
T					0.XX ±0.13	projection	VERTICAL SIGNAL HDR 8 ROW	
				angles	.XXX ±.051		P.F. 96 POS. SPECIAL LOAD EXT.	
				dr	0° ±2°	MM	product family	METRAL 2000
				engr	E. KROPER. 2001-01-10	← MM →	size	dwg no
				chr	J. VOLSTORF 2001-01-10	scale	A	74978
				appd	J. VOLSTORF 2001-01-10	1:1	code	213
sheet index	revision sheet						sheet	3

B

PRODUCT NUMBER
SEE SHEET 1

PRESS-FIT HOLES	OPTION 1
HOLE DIAMETER AFTER PLATING	0.65-0.80
DRILLED HOLE	0.81-0.86 (0.85 DRILL)
COPPER PLATING	0.025 MIN
SnPb PLATING	0.005-0.015

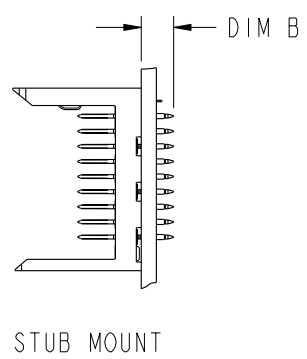
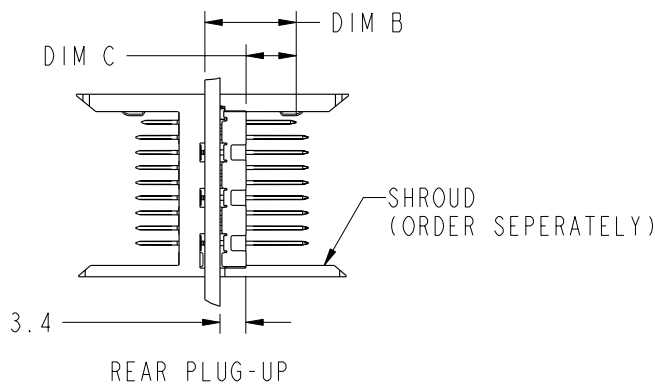

SEE PRINT 58351 FOR ADDITIONAL PCB INFORMATION.

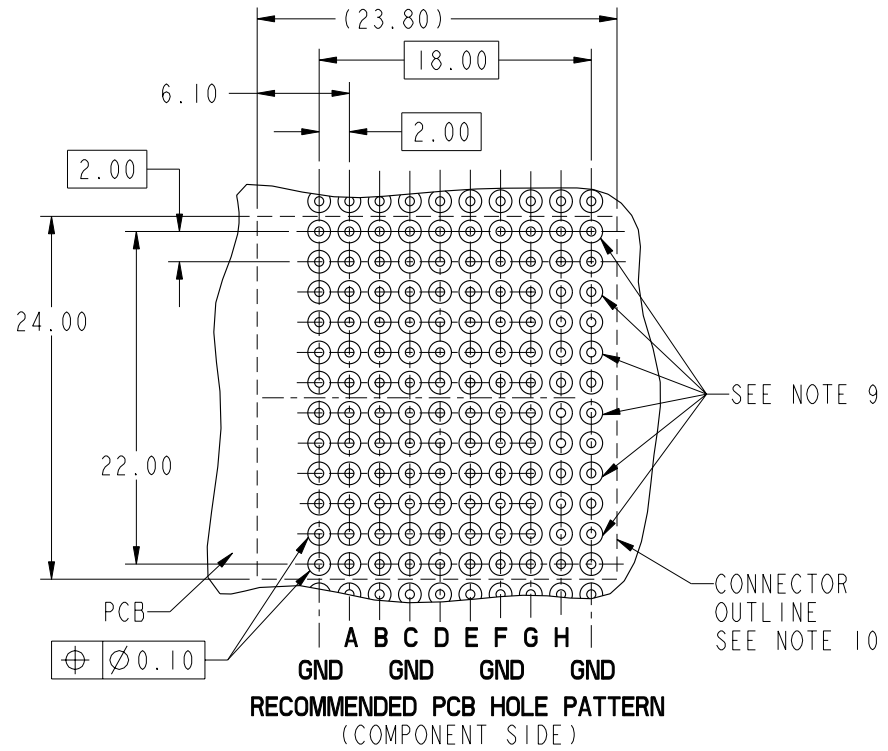

This document is the property of and embodies
 CONFIDENTIAL and PROPRIETARY information of FCI.
 No part of the information shown on this
 document may be used in any way or disclosed
 to others without the written consent of FCI.
 Copyright FCI.

mat'l code SEE NOTE 5				tolerances unless otherwise specified		CUSTOMER	FCI www.fciconnect.com	
ltr	ecr no.	dr	date	linear	0.X ±0.3	COPY	title	
T				angles	0.XX ±0.13	projection	VERTICAL SIGNAL HDR 8 ROW P.F. 96 POS. SPECIAL LOAD EXT.	
				dr	.XXX ±.051	MM	product family	
				enrg	0° ±2°		METRAL 2000	
				chr	E. KROPER. 2001-01-10	scale	code	
				appd	J. VOLSTORF 2001-01-10		213	
					J. VOLSTORF 2001-01-10	A	sheet	
					J. VOLSTORF 2001-01-10	1:1	4	
sheet index	revision sheet						cage code	
							22526	

SPECIAL LOAD PATTERNS		
PRODUCT #	ROW	PIN CODES
74978-X02001 SEE NOTE 16 LEAD FREE OPTION	H	01
	G	
	F	
	E	
	D	
	C	
	B	
	A	
	GND	
74978-X02006 *RPU SEE NOTE 16 LEAD FREE OPTION	H	48
	G	
	F	
	E	
	D	
	C	
	B	
	A	
	GND	
74978-X02011 SEE NOTE 16 LEAD FREE OPTION	H	02
	G	
	F	
	E	
	D	
	C	
	B	
	A	
	GND	
74978-X02012 *RPU SEE NOTE 16 LEAD FREE OPTION	H	44
	G	
	F	
	E	
	D	
	C	
	B	
	A	
	GND	
74978-X02013 *RPU SEE NOTE 16 LEAD FREE OPTION	H	06
	G	
	F	
	E	
	D	
	C	
	B	
	A	
	GND	

PCB THICKNESS
RANGE FOR REAR
PLUG UP
APPLICATIONS:
5.50 - 6.80

PCB THICKNESS
RANGE FOR REAR
PLUG UP
APPLICATIONS:
2.95 - 3.80

PCB THICKNESS
RANGE FOR REAR
PLUG UP
APPLICATIONS:
3.30 - 4.95 FOR
METRAL 1000
(RECEPTACLE)
APPLICATIONS,
AND 3.30-4.95
FOR METRAL 4000
APPLICATIONS

SPECIAL LOAD PATTERNS		
PRODUCT #	ROW	PIN CODES
74978-X02050 SEE NOTE 16 LEAD FREE OPTION	H	02
	G	03
	F	04
	E	02
	D	03
	C	04
	B	02
	A	03
	GND	02
	74978-X02051 *RPU SEE NOTE 16 LEAD FREE OPTION	H
G		24
F		12
E		25
D		24
C		12
B		25
A		24
GND		49
74978-X02052 *RPU SEE NOTE 16 LEAD FREE OPTION		H
	G	
	F	
	E	
	D	
	C	
	B	
	A	
	GND	
	74978-X02053 SEE NOTE 16 LEAD FREE OPTION	H
G		
F		
E		
D		
C		
B		
A		
GND		

PCB THICKNESS
RANGE FOR REAR
PLUG UP
APPLICATIONS:
5.70 - 7.20 FOR
METRAL 1000
(RECEPTACLE)
APPLICATIONS,
AND 6.00-7.20
FOR METRAL 4000
APPLICATIONS

PCB THICKNESS
RANGE FOR REAR
PLUG UP
APPLICATIONS:
2.95 - 5.30 FOR
METRAL 1000
(RECEPTACLE)
APPLICATIONS,
AND 3.30-5.30
FOR METRAL 4000
APPLICATIONS

PCB THICKNESS
RANGE FOR REAR
PLUG UP
APPLICATIONS:
4.00 - 5.70 FOR
METRAL 1000
(RECEPTACLE)
APPLICATIONS,
AND 4.05 - 5.70
FOR METRAL 4000
APPLICATIONS

SPECIAL LOAD PATTERNS		
PRODUCT #	ROW	PIN CODES
74978-X02054 SEE NOTE 16 LEAD FREE OPTION	H	03
	G	
	F	
	E	
	D	
	C	
	B	
	A	
	GND	
	GND	02

*REAR PLUG-UP PART NUMBER



This document is the property of and embodies
 CONFIDENTIAL and PROPRIETARY information of FCI.
 No part of the information shown on this
 document may be used in any way or disclosed
 to others without the written consent of FCI.
 Copyright FCI.

mat'l code SEE NOTE 5				tolerances unless otherwise specified		CUSTOMER	www.fciconnect.com		
ltr	ecn no.	dr	date	linear	0.X ±0.3	projection	COPY		
T					0.XX ±0.13			title	
					.XXX ±.051			VERTICAL SIGNAL HDR 8 ROW P.F. 96 POS. SPECIAL LOAD EXT.	
				angles	0° ±2°		product family		
				dr	E. KROPER. 2001-01-10		METRAL 2000		
				engr	J. VOLSTORF 2001-01-10		code	213	
				chr	J. VOLSTORF 2001-01-10		size	dwg no	
				appd	J. VOLSTORF 2001-01-10	scale	A	74978	
sheet	revision							sheet	
index	sheet							5	

cage code 22526

PRODUCT NUMBER
SEE SHEET 1

NOTES:

- 1. SEE APPLICATION SPECIFICATION GS-20-010 FOR INFORMATION ON AVAILABLE TOOLING, CIRCUIT BOARD DESIGN CONSIDERATIONS, REPAIR PROCEDURES AND PRODUCT OFFERINGS.
- 2. SEE FCI PUBLICATION 950511-028 FOR "ELECTRICAL PERFORMANCE DATA FOR DIFFERENTIAL APPLICATIONS."
- 3. SEE FCI PUBLICATION 950511-028 FOR "ELECTRICAL PERFORMANCE DATA FOR SINGLE-ENDED APPLICATION."
- 4. UNLESS OTHERWISE SPECIFIED, ALL DIMENSIONS AND TOLERANCES ARE IN ACCORDANCE WITH ASME Y14.5M, 1994
- 5. HOUSING MATERIAL: LIQUID CRYSTAL POLYMER, 30% GLASS FILLED, FLAME RETARDANT PER UL 94-V0.
PIN MATERIAL: PHOSPHER BRONZE
GROUND SPRING MATERIAL: PHOSPHER BRONZE
STRIPLINE SHIELD MATERIAL: PHOSPHER BRONZE
- 6. PLATING INFORMATION: PLATING ON CONTACT AREA MEETS THE PERFORMANCE LEVELS AS SHOWN IN TABLE ON SHEET 1. PLATING ON "LF" TAILS IS Sn. PLATING ON ALL OTHER TAILS IS SnPb.
- 7. DIMENSIONAL RESTRICTIONS OF PINS IN HEADERS.
FOR MATING WITH METRAL 1000 RECEPTACLES
DIM A : 5.00mm MIN, 8.00mm MAX FOR ROWS A-H
DIM A : 5.00mm MIN, 5.75mm MAX FOR ROW GND NEXT TO ROW A
DIM C : 5.00mm MIN, 8.00mm MAX FOR ROWS A-H
DIM C : 4.60mm MIN, 6.30mm MAX FOR ROW GND NEXT TO ROW A
FOR MATING WITH METRAL 4000 RECEPTACLES
DIM A : 5.00mm MIN, 6.50mm MAX FOR ROWS A, B, D, E, G & H
DIM A : 5.00mm MIN, 8.00mm MAX FOR ROWS C & F
DIM A : 5.00mm MIN, 5.75mm MAX FOR ROW GND NEXT TO ROW A
DIM C : 5.00mm MIN, 7.00mm MAX FOR ROWS A, B, D, E, G & H
DIM C : 5.00mm MIN, 8.00mm MAX FOR ROWS C & F
DIM C : 4.60mm MIN, 6.30mm MAX FOR ROW GND NEXT TO ROW A
- 8. THE MIN PCB THICKNESS FOR REAR PLUG-UP APPLICATIONS IS 2.9mm SINCE THE COMPLIANT SECTIONS OF THE GROUND SPRING OF THE HEADER DIRECTLY OPPOSE THE GROUND SPRING OF THE SHROUD. THE MIN PCB THICKNESS FOR FRONT PLUG-UP ONLY APPLICATIONS IS 1.6mm.

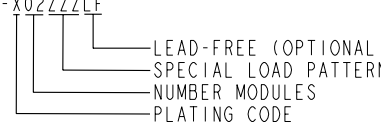
- 9. THESE HOLES ARE NEEDED FOR REAR PLUG-UP DESIGNS USING A SHROUD AND MAY BE OMITTED FOR FRONT PLUG-UP ONLY DESIGNS.
- 10. THE 'CONNECTOR OUTLINE' IS THE MIN OUTLINE REQUIRED. TO DETERMINE THE OUTLINE NECESSARY TO PERMIT THE VARIOUS TYPES OF REPAIR OPERATIONS, SEE APPLICATION SPECIFICATION GS-20-010.
- 11. CURRENT RATING : 1 AMP PER PIN
- 12. TEMPERATURE RANGE : -55°C TO +105°C
- 13. P/N 74978-X02ZZZLF

- 14. FOR FRONT PLUG-UP APPLICATIONS, THE EVEN NUMBERED PINS IN ROW 'C' AND 'F' CAN BE USED FOR POWER AS WELL AS FOR GROUND. IF THE SURROUNDING PINS ARE NOT USED FOR POWER, THEN EACH PIN CAN CARRY 3 AMPS. IF THE SURROUNDING PINS ARE USED FOR POWER, THEN EACH PIN CAN CARRY 1 AMP. WHEN THE SURROUNDING PINS ARE USED ONLY FOR LOW SPEED SIGNALS, THEN THE EVEN NUMBERED 'C' AND 'F' ROW PINS CAN ALSO BE USED FOR LOW SPEED SIGNALS. THIS IS NOT TRUE FOR REAR PLUG-UP APPLICATIONS USING METRAL 2000 SHROUD AS IN THIS CASE ALL 'C' AND 'F' ROW PINS ARE COMMON TO GROUND.
- 15. PRODUCTS WHERE THE PART NUMBER ENDS IN LF MEET EUROPEAN UNION DIRECTIVES AND OTHER COUNTRY REGULATIONS AS DESCRIBED IN GS-22-008. ALL PRODUCTS WILL WITHSTAND EXPOSURE TO 260°C FOR 60 SECONDS IN A CONVECTION, INFRA-RED OR VAPOR PHASE REFLOW OVEN.
- 16. FOR LEAD FREE PART NUMBERS ADD 'LF' SUFFIX. EXAMPLE: 74978-XXXXLF
- 17. PIN TYPE IS AT THE MANUFACTURERS OPTION AND CAN BE EITHER BABY-H OR EYE OF THE NEEDLE STYLE



This document is the property of and embodies CONFIDENTIAL and PROPRIETARY information of FCI. No part of the information shown on this document may be used in any way or disclosed to others without the written consent of FCI. Copyright FCI.

mat'l code SEE NOTE 5				tolerances unless otherwise specified		CUSTOMER	FCI www.fciconnect.com	
ltr	ecn no.	dr	date	linear	0.X ±0.3	COPY	title VERTICAL SIGNAL HDR 8 ROW P.F. 96 POS. SPECIAL LOAD EXT.	
T					0.XX ±0.13	projection		
					.XXX ±.051			
				angles	0° ±2°		product family METRAL 2000 code	
				dr	E. KROPER. 2001-01-10	MM ←→ scale 1:1	size	213
				enrg	J. VOLSTORF 2001-01-10		dwg no	6
				chr	J. VOLSTORF 2001-01-10		A	74978
				appd	J. VOLSTORF 2001-01-10			
sheet index	revision sheet							