



LED Lighting

- General Purpose ICs
- Video and Imaging ICs
- Audio ICs
- IT Equipment ICs
- Consumer Product ICs
- Automotive ICs
- Discrete Semiconductors
- Optoelectronics
- Modules

APPLICATION GUIDE 2009 1st



www.rohm.com

Site Search

A detailed content : the access from the above-mentioned code.



Improve your living space with ROHM LED lighting products.



LDO

Compatible with ceramic capacitors for phase compensation.

High Voltage Resistance Regulators

- New** BD00C0AWFP (Variable Output, 1A)
- ☆BD00D0AWHFP (Variable Output, 2A)
- New** BD80C0AFPS (8V Output, 1A)
- New** BD90C0AFPS (9V Output, 1A)

High voltage resistance regulators compatible with ceramic capacitors for phase compensation.

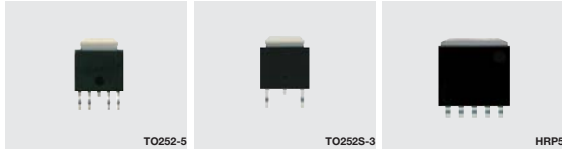

Ultra-compact package compatible with 25V input.

High Input Voltage Resistance Series for Microcontrollers

- ☆BD35603HFN (3.3V/100mA)
- New** BD35605HFN (5.0V/100mA)
- New** BD35630HFV (0.788~15V/300mA)

25V Input, 100mA Power Supply Series (5V / 3.3V Fixed Output Type).
20V Input, 300mA Power Supply Series (Variable Output Type).

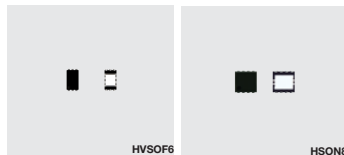

DC / DC converter

Optimized for noise removal.

Chip tantalum capacitors



<Conductive polymer type>TCO / TCTO series

- M case (1608 [0603] size) 15µF Max. (TCTO series)
- P case (2012 [0805] size) 47µF Max. (TCTO series)
- AL case(3216 [1206] low profile size) 100µF Max. (TCTO series)
- A case (3216 [1206] size) 68µF Max. (TCO series)
- B case (3528 [1411] size) 330µF Max. (TCO series)

Utilizing conductive polymer at the cathode results in lower ESR while improving incombustibility.



Power supply block

Industry's fastest switching speed.

High Voltage Resistance MOSFETs

- R5007ANX (V_{DSS}=500V, I_D=7A, TO-220FM)
- R5016ANX (V_{DSS}=500V, I_D=16A, TO-220FM)
- R6008ANX (V_{DSS}=600V, I_D=8A, TO-220FM)
- R6010ANX (V_{DSS}=600V, I_D=10A, TO-220FM)

New low R_{DS(on)} process utilized for dramatically improved switching speed (approx. 30% faster).

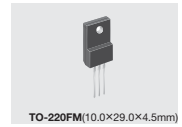

Ultra-fast recovery ensures extremely low heat generation.

Fast Recovery Diodes

RF series

Unique technology ensures ultra-fast switching speed and low V_f.

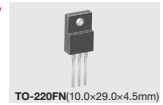

Advanced element features more than twice the voltage resistance of conventional products.

High Voltage Resistance Chip Resistors

- KTR03 (1608 [0603] size / 350V)
- KTR10 (2012 [0805] size / 400V)
- KTR18 (3216 [1206] size / 500V)
- KTR25 (3225 [1210] size / 600V)



Interface / Switch Block

Free up lighting control (i.e. ON / OFF) from restrictive wired systems with ROHM's versatile wireless solutions.

Short Distance Wireless Communication Modules

New BW9419

Integrates all required functions, including a IEEE802.11b / g / i baseband processor and RF circuit, into a single module. Enable to customize according to applications as well.

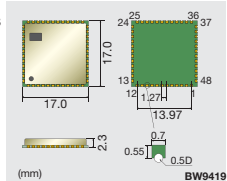

Detects ambient light for optimized dimming.

Ambient Light Sensor ICs

- BH1603FVC (Analog Output type)
- BH1715FVC (Digital Output type)

The BH1603FVC is Analog Current Output Type.
The BH1715FVC is Digital Serial Output Type.



Improve your designs with touch switch capability.

Capacitive Switch ICs

- BU21050FS [8ch (Max.) sensor input]
- BU21051FS [2ch (Max.) sensor input]

ICs for microcontroller-less PIO drive touch switch systems.



High quality voice guidance and large output BGM.

High Performance Class D Speaker Amplifiers (5W to 17W Output)

- BD5423EFS (17W+17W Output Type)
- New** BD5426EFS (10W+10W Output Type)
- New** BD5427EFS (7W+7W Output Type)
- BD5413EFV (5W+5W Output Type)

The industry's highest efficiency, combined with low heat generation, ensure significantly greater energy savings while reducing the amount of space required for high fidelity audio playback in next-generation lighting devices that integrate audio functionality.



HTSSOP-A44



HTSSOP-B24

Add audio functionality to compact lighting devices.

High Performance Class D Speaker Amplifiers (Compact 2.5W Output Type)

- BD5460GUL (Voltage gain : 6dB)
- New** BD5461GUL (Voltage gain : 12dB)

ROHM Class D speaker amps integrate multiple protection circuits that contribute to safer designs. The compact high efficiency, low-heat generating design decreases mounting area.



VCSP50L1

Expand your lighting application by adding voice guidance capability.

Voice Generation Decoder ICs

- New** BU6954 series (Built-in Mask ROM Type 4ch Synchronous Playback)
- New** BU6940FV (External Flash ROM Type with 2ch Synchronous Playback)
- BU6929FV (External Flash ROM Type with 1ch Playback)

All required functions are built-in, reducing microcontroller load to practically zero. Enables high quality playback of compressed audio.

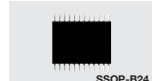

SSOP-B24

Improving lighting and illumination with semiconductor technology.

Innovate your lighting designs with ROHM's broad lineup of versatile lighting products.



Driver Block



Simplifies standard lighting designs.

High Accuracy Constant Voltage / Current Controller IC

BD6550G

Configure simple high accuracy LED lighting solutions (i.e. standard, guidance lights) by connecting an AC / DC converter.



SSOP6



Precise dimming with PWM control.

LED Drivers for Down lights

BD6583MUV-A (6W Output)
BD6592MUV (10W Output)

Integrates a PWM DC / DC converter (42V max. step-up) and current driver with PWM dimming capability.



VQFN024V4040



High power LEDs for high performance sets.

High Power LED Drivers

New BD9207FPS

High power LED drivers with built-in step-down switching regulator.

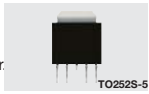

TO262S-5



LED dot matrixes for information display.

LED Driver for Dot Matrix Displays

New BH6948GU

7x7 (max.) LED dot matrix driver with built-in charge pump featuring automatic gain switching.

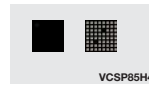

VCSF85H4



Simultaneous low Vf and Ir.

Schottky Barrier Diodes

RSX101VA-30 ($V_{RM}=30V, I_o=1A$)
RSX071VA-30 ($V_{RM}=30V, I_o=0.7A$)
RSX051VA-30 ($V_{RM}=30V, I_o=0.5A$)



TUMD2(1.3x2.5x0.6mm)



Ideal for noise suppression in power supply lines.

Three-terminal EMI filters

MCF18 series (1608 [0603] size)

Supports rated currents up to 4A in the 1608 size.
Low internal resistance (20mΩ max.) ensures low loss.



MCF series

LED Lighting Block

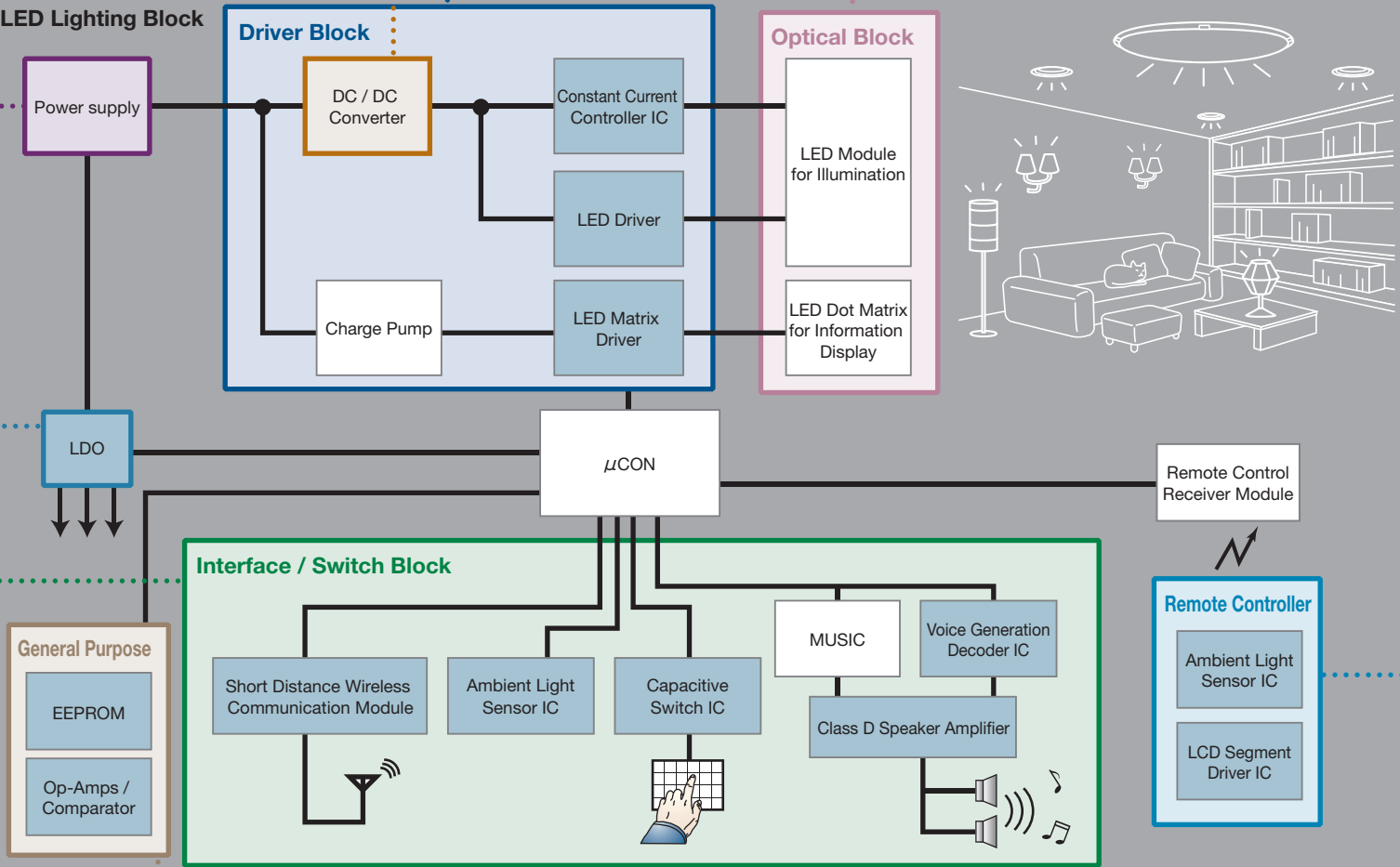

General-purpose Products



High reliability series optimized for LED lighting correction.

High Reliability EEPROMs

BR24L□□ series BR24S□□□ series
BR25L□□□ series **New** BR25S□□□ series
BR93L□□ series

Original W-CELL technology utilized for high reliability.
Operation from 1.7V possible.



SOP8



Large variety of Op-Amp, Comparators for any application and environment.

Operational Amplifiers / Comparators

BA2904 family **New** BA2904S family
BA2903 family **New** BA2903S family
BA4558 family BA4558R family
BU7262 family BU7262S family
New BD7542 family **New** BD7542S family

... And more than 20 products.

ROHM offers a broad lineup of op-amps and comparators in various electrical / temperature characteristics and package types to suit virtually any need.



SOP8

MSOP8



Optical Block

LED Colorful LEDs

Light Sources for Indicators

SML-Z series
(3.5x2.8x1.9mm)



SML-512 series
(1.6x0.8x0.55mm)

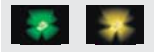

SML-212 series
(2.0x1.25x0.8mm)

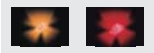

SML-01 series
(3.0x2.0x1.3mm)
With reflector



LED Shining LEDs

High Brightness /
High Heat radiation white LEDs

TOP View type
PSML2 (SMLK series)



New Side view type

PSML-S
PSML-ST
Compact types available (0.8mm, t=2.15mm)



LED Rendering LEDs

High Power LEDs

☆1W, 3W, 5W



Features a color rendering index Ra > 95 and a CIE rank of 1A – suitable for fine art (museum-quality) and color test applications.



Remote Control

Backlight brightness control based on ambient conditions.

Ambient Light Sensor ICs

BH1603FVC (Analog Output type)
BH1715FVC (Digital Output type)

The BH1603FVC is Analog Current Output Type.
The BH1715FVC is Digital Serial Output Type.



WSOF6

For clear display in remote controlled LCDs.

LCD Segment Driver ICs

New BU979□ series

A buffer amp integrating an LCD drive voltage generator is built in, reducing power consumption.
A wide lineup is offered, from 80-segment to 200-segment models.

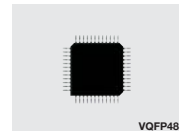

VQFP48

A broad lineup is offered in both leaded and surface mount configurations.

Remote Control Receiver Modules

RPM series



RPM series



Modules

Easy drive with AC input.

High power LED Drivers for Illumination

BP58□ series

Constant current (250 to 350mA).
Significantly reduced current consumption contribution to greater energy savings.

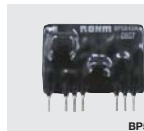

BP5843A

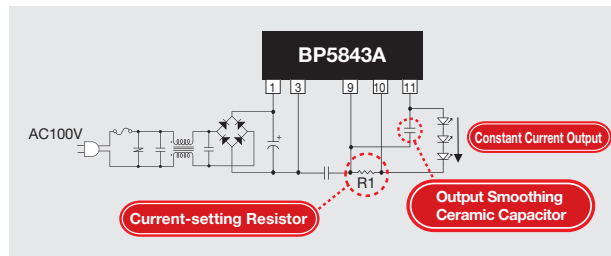

Flexible control for smooth dimming.

LED Driver with Dimming Function

BP5845W

Dimming possible using only PWM input.
Constant current output: 166 to 360mA.



BP5845W

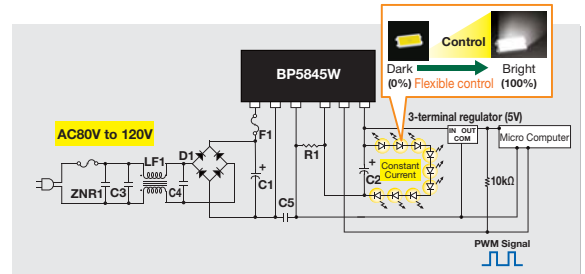

Supports a variety of lighting needs.

LED Lighting Modules

LTG series

High brightness with less heat generation using standard LEDs.
Unique reflectors ensure uniform chromaticity.

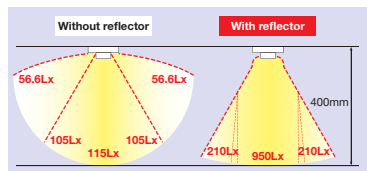

IC Product Specifications

LDO

High Voltage Regulators

1A Standard Variable Output LDO Regulators

Part No.	Output Voltage (V)	Output Voltage Accuracy (%)	Output Current (A)	Max.Voltage (V)	Ripple Rejection (dB)	Protection circuit
New BD00C0AWFP	3.0 to 15.0	±1.0	1.0	35	55	Over current / Temperature

2A Standard Variable Output LDO Regulators

Part No.	Output Voltage (V)	Output Voltage Accuracy (%)	Output Current (A)	Max.Voltage (V)	Ripple Rejection (dB)	Protection circuit
☆ BD00D0AWHFP	3.0 to 15.0	±1.0	2.0	35	55	Over current / Temperature

1A Standard Fixed Output LDO Regulators

Part No.	Output Voltage (V)	Output Voltage Accuracy (%)	Output Current (A)	Max.Voltage (V)	Ripple Rejection (dB)	Protection circuit
New BD80C0AFPS	8.0	±1.0	1.0	35	50	Over current / Temperature
New BD90C0AFPS	9.0	±1.0	1.0	35	50	Over current / Temperature

High Input Voltage Regulators for Microcontrollers

100mA Linear Regulators

Part No.	Input Voltage (V)	Output Voltage (V)	Voltage Accuracy (%)	Output Current (mA)	Over current Protection	NRCS (Soft Start)
☆ BD35603HFN	4.5 to 25.0	3.3	±1	100	✓	1ms
New BD35605HFN	6.2 to 25.0	5.0	±1	100	✓	1ms

300mA Linear Regulator

Part No.	Input Voltage (V)	Output Voltage (V)	Voltage Accuracy (%)	Output Current (mA)	Over current Protection	NRCS (Soft Start)
New BD35630HFV	4.5 to 20	Variable (0.788 to 15)	±1	300	✓	1ms

Interfaces / Switches

Short Distance Wireless Communication Module

Part No.	Supply Voltage (V)	Host CPU I/F	Wireless LAN Standard	Internal Secure Engine
New BW9419	3.0 to 3.6	SPI / SDIO	IEEE802.11b / g	IEEE802.11i

IC Ambient Light Sensor ICs

Analog Current Output Ambient Light Sensor IC

Part No.	Output Method	Supply Voltage (V)	Sensitivity Variation (%)	Output Sensitivity Switching	Brightness Measurement Range (lx)	Operating Temperature Range (°C)
BH1603FVC	Current (Source)	2.4 to 5.5	±15	3 steps	0 to 100,000	-40 to +85

Digital 16bit Serial Output Ambient Light Sensor IC

Part No.	Output Method	Supply Voltage (V)	Sensitivity Variation (%)	I/O Voltage	Brightness Measurement Range (lx)	Operating Temperature Range (°C)
BH1715FVC	I ² C I / F	2.4 to 3.6	±15	1.65 to Vcc	0 to 65,000	-40 to +85

LSI Capacitive Switch ICs

Capacitive Sensor/Switch Control ICs

Part No.	Supply Voltage (V)	Sensor Input ch.	Interface
BU21050FS	4.5 to 5.5	Max. 8ch	PIO
BU21051FS	4.5 to 5.5	Max. 2ch	PIO

High Performance Class D Speaker Amplifiers (5W - 17W Output)

17W+17W Analog Input Class D Speaker Amplifier

Part No.	Supply Voltage (V)	Permissible Loss (W)	Quiescent Current (mA)	Voltage Gain (dB)	Output Power (W)
BD5423EFS	10.0 to 16.5	4.5 (Two-layer board)	25 (Vcc=12V)	28	10 (Vcc=12V, RL=8Ω) / 17 (Vcc=12V, RL=4Ω)

10W+10W Analog Input Class D Speaker Amplifier

Part No.	Supply Voltage (V)	Permissible Loss (W)	Quiescent Current (mA)	Voltage Gain (dB)	Output Power (W)
New BD5426EFS	10.0 to 16.5	4.5 (Two-layer board)	25 (Vcc=12V)	28	9 (Vcc=12V, RL=8Ω) / 10 (Vcc=13V, RL=8Ω)

7W+7W Analog Input Class D Speaker Amplifier

Part No.	Supply Voltage (V)	Permissible Loss (W)	Quiescent Current (mA)	Voltage Gain (dB)	Output Power (W)
New BD5427EFS	10.0 to 16.5	4.5 (Two-layer board)	25 (Vcc=12V)	28	7 (Vcc=12V, RL=8Ω)

5W+5W Analog Input Class D Speaker Amplifier

Part No.	Supply Voltage (V)	Permissible Loss (W)	Quiescent Current (mA)	Voltage Gain (dB)	Output Power (W)
BD5413EFV	6.0 to 10.5	2.8 (Two-layer board)	12 (Vcc=9V)	30	4 (Vcc=9V, RL=8Ω) / 5 (Vcc=9V, RL=6Ω)

High Performance Class D Speaker Amplifiers (Compact 2.5W Output Type)

2.5W Monaural Class D Speaker Amplifier Compatible with Differential Analog Input

Part No.	Supply Voltage (V)	Permissible Loss (W)	Quiescent Current (mA)	Voltage Gain (dB)	Output Power (W)
BD5460GUL	2.5 to 5.5	0.69	2.0 (Vcc=3.6V)	6	0.85 (Vcc=3.6V, RL=8Ω) / 2.5 (Vcc=5V, RL=4Ω)
New BD5461GUL	2.5 to 5.5	0.69	2.0 (Vcc=3.6V)	12	0.85 (Vcc=3.6V, RL=8Ω) / 2.5 (Vcc=5V, RL=4Ω)

Voice Generation Decoder ICs

Hi-Fi Voice Synthesis IC with Internal Mask ROM

*The number decided by user's voice data is applied in the □ of Part No.

Part No.	Supply Voltage (V)	Clock (MHz)	Interface	Internal ROM Capacity (bit)	No. of Simultaneous Playback Channels	DAC
New BU6954-□□	2.7 to 5.5 (single)	16.384 to 2.048	Synchronous Serial	4M	4ch	16bit

External Serial Flash ROM Type Hi-Fi Voice Synthesis ICs

Part No.	Supply Voltage (V)	Clock (MHz)	Interface	External ROM Capacity (bit)	No. of Simultaneous Playback Channels	DAC
New BU6940FV	2.7 to 3.6 (single)	16.384 to 2.048	Synchronous Serial	Max. 128M	2ch (High quality)	16bit
New BU6929FV	2.7 to 3.6 (single)	16.384 to 2.048	Synchronous Serial	Max. 128M	1ch	16bit

Driver Block

High Accuracy Constant Voltage / Current Controller IC

Part No.	Supply Voltage (V)	No. of Amps	Voltage Control Loop Reference Voltage(V)	Voltage Control Loop (GMV/mA / mV)	Detection Voltage(mV)	Current Control Loop (GM/mA / mV)	Output Short Circuit Current(mA)
BD6550G	2.5 to 12	2	1.210	4.0	200	4.0	20

LED Drivers for Down lights

Part No.	Supply Voltage (V)	No. of LEDs	Output Voltage (V)	Output Current (mA)	Control Interface
BD6583MUV-A	3.1 to 22	72 Max. → 12 in series x 6 lines (Vf restrictions exist)	43.0 Max.	25 (Per line)	Pin Logic Setting
BD6592MUV	3.1 to 22	72 Max. → 12 in series x 6 lines (Vf restrictions exist)	43.0 Max.	40 (Per line)	Pin Logic Setting

High Power LED Driver

Part No.	Supply voltage (V)	Maximum Output Current (A)	Ron (Ω)	Oscillation Frequency (kHz)	Protection circuit
New BD9207FPS	8.0 to 35.0	1.5	1.0 (Typ.)	900	Over current / Temperature

LED Driver for Dot Matrix Displays

Part No.	Supply voltage (V)	LED Connection Method	Step-up Circuit	Aux LED	Control Interface
New BH6948GU	3.15 to 4.5	Parallel	Charge Pump	7x7 dot matrix 31mA Max. 31-step PWM slope control function	SPI

General-purpose ICs

High reliability EEPROMs

I²C BUS

Part No.	Capacity (Bits)	Operating Voltage Range (V)	Write Cycle Time (Max.)(ms)	Operating Temperature Range (°C)	No. of Writes Lifetime (Ta=25°C)	Date Retention Life (year) (Ta=25°C)
BR24L□□ series	1K to 64K	1.8 to 5.5	5	-40 to 85	10 ⁶	40
BR24S□□□ series	8K to 256K	1.7 to 5.5	5	-40 to 85	10 ⁶	40

SPI BUS

Part No.	Capacity (Bits)	Operating Voltage Range (V)	Write Cycle Time (Max.)(ms)	Operating Temperature Range (°C)	No. of Writes Lifetime (Ta=25°C)	Date Retention Life (year) (Ta=25°C)
BR25L□□0 series	1K to 64K	1.8 to 5.5	5	-40 to 85	10 ⁶	40
New BR25S□□□ series	16K to 256K	1.7 to 5.5	5	-40 to 85	10 ⁶	40

Microwire BUS

Part No.	Capacity (Bits)	Operating Voltage Range (V)	Write Cycle Time (Max.)(ms)	Operating Temperature Range (°C)	No. of Writes Lifetime (Ta=25°C)	Date Retention Life (year) (Ta=25°C)
BR93L□□ series	1K to 16K	1.8 to 5.5	5	-40 to 85	10 ⁶	40

Op-amps / Comparators

Ground Sense Op-amps

Part No.	Supply Voltage (V)	Circuit current (mA)	Input Offset Voltage (mV)	Output Current (mA)	Slew Rate (V/μs)	Gain Bandwidth (MHz)
BA2904family	3 to 32	0.7	2	30	0.2	0.5
New BA2904Sfamily	3 to 32	0.7	2	20	0.2	0.5

Ground Sense Comparators

Part No.	Supply Voltage (V)	Circuit current (mA)	Input Offset Voltage (mV)	Output Current (mA)	Slew Rate (dB)	Response (μs)
BA2903family	2 to 36	0.6	2	16	100	1.3
New BA2903Sfamily	2 to 36	0.6	1	16	100	1.3

Low Noise Op-amps

Part No.	Supply Voltage (V)	Circuit current (mA)	Input Offset Voltage (mV)	Output Current (mA)	Slew Rate (V/μs)	Gain Bandwidth (MHz)
BA4558family	±4 to ±15	3.0	0.5	10	1.0	2.0
BA4558Rfamily	±4 to ±15	3.0	0.5	10	1.0	2.0

Low Voltage Input / Output Full Swing CMOS Op-amps

Part No.	Supply Voltage (V)	Circuit current (μA)	Input Offset Voltage (mV)	Output Current (mA)	Slew Rate (V/μs)	Gain Bandwidth (MHz)
BU7262family	1.8 to 5.5	550	1	10	1.1	2.0
BU7262Sfamily	1.8 to 5.5	550	1	10	1.1	2.0

High Voltage Input / Output Full Swing Op-amps

Part No.	Supply Voltage (V)	Circuit current (μA)	Input Offset Voltage (mV)	Output Current (mA)	Slew Rate (V/μs)	Gain Bandwidth (MHz)
New BD7542family	5 to 14.5	400	1	4	0.3	0.6
New BD7542Sfamily	5 to 14.5	400	1	4	0.3	0.6

Remote Controllers

Ambient Light Sensor ICs

Analog Current Output Ambient Light Sensor IC

Part No.	Output Type	Supply voltage (V)	Sensitivity Variation (%)	Output Sensitivity Switching	Brightness Measurement Range (lx)	Operating Temperature Range (°C)
BH1603FVC	Current (Source)	2.4 to 5.5	±15	3 steps	0 to 100,000	-40 to +85

Digital 16bit Serial Output Ambient Light Sensor IC

Part No.	Output Type	Supply voltage (V)	Sensitivity Variation (%)	I / O Voltage	Brightness Measurement Range (lx)	Operating Temperature Range (°C)
BH1715FVC	I ² C I/F	2.4 to 3.6	±15	1.65 to Vcc	0 to 65,000	-40 to +85

LCD Segment Driver ICs

80-segment Driver (20SEGx4COM)

Part No.	Output	Supply voltage (V)	LCD Drive Voltage (V)	Duty	Bias	I / F
New BU9796FS	80SEG (20SEGx4COM)	2.5 to 5.5		1/4	1/2, 1/3	2 line Serial

140-segment Drivers (35SEGx4COM)

Part No.	Output	Supply voltage (V)	LCD Drive Voltage (V)	Duty	Bias	I / F
New BU9795AKV	MAX140SEG (35SEGx4COM)	2.5 to 5.5		1/4	1/2, 1/3	3 line Serial
New BU9795AFV						
☆ BU9795AGUV						

200-segment Drivers (50SEGx4COM)

Part No.	Output	Supply voltage (V)	LCD Drive Voltage (V)	Duty	Bias	I / F
New BU9794KV	200SEG (50SEGx4COM)	2.5 to 5.5	2.5 to 5.5	1/4	1/2, 1/3	3 line Serial
New BU9799KV	200SEG (50SEGx4COM)	2.5 to 5.5	2.5 to 5.5	1/4	1/2, 1/3	2 line Serial

Discrete Product Specifications

Power supply

High Voltage Resistance MOSFETs

Part No.	Package	Polarity	V _{DSS} (V)	I _D (A)	P _D (W) (T _c =25°C)	R _{DS(on) Typ. (Ω)} V _{GS} =10V	Drive Voltage (V)
R5007ANX	TO-220FM	Nch	500	7	40	0.8	10
R5016ANX			500	16	50	0.21	10
R6008ANX			600	8	50	0.6	10
R6010ANX			600	10	50	0.43	10

Fast Recovery Diodes

Part No.	Package	V _{RM} (V)	I _O (A)	I _{FSM} (A)	V _F (V)	I _F (A)	I _R (mA)	V _R (V)
RF1001T2D	TO-220FN	200	10	80	0.93	5	10	200
RF2001T2D	TO-220FN	200	20	100	0.93	10	10	200
RF2001T3D	TO-220FN	350	20	100	1.3	10	10	300
RF2001T4S	TO-220FN	430	20	100	1.6	20	10	400
RF08L6S	PMDS	600	0.8	20	1.3	0.8	10	600
RF2L6S	PMDS	600	1.5	40	1.55	1.5	10	600

Driver & DC / DC Converter

MOSFETs

Part No.	Package	Polarity	V _{DSS} (V)	I _D (A)	P _D (W) (T _a =25°C)	R _{DS(on) Typ. (mΩ)}			Q _g (nC)	Drive Voltage (V)	
						V _{GS} =2.5V	V _{GS} =4V	V _{GS} =4.5V V _{GS} =10V			
SP8K23	SOP8	Nch+Nch	45	5	2	—	36	33	26	8.6	4
SP8K33	SOP8	Nch+Nch	60	5	2	—	40	38	34	8	4
RTR030N05	TSMT3	Nch	45	3	1	68	53	48	—	6.2	2.5
RSR030N06	TSMT3	Nch	60	3	1	—	75	70	60	5	4
QS6K21	TSMT6	Nch+Nch	45	1	1.25	415	—	310	300	1.5	2.5

Schottky Barrier Diodes

Part No.	Package	V _{RM} (V)	I _O (A)	I _{FSM} (A)	V _F (V)	I _F (A)	I _R (mA)	V _R (V)
RSX051VA-30	TUMD2	30	1	5	0.47	1	0.2	30
RSX071VA-30	TUMD2	30	0.7	5	0.42	1	0.2	30
RSX101VA-30	TUMD2	30	0.5	5	0.39	1	0.2	30
RSX1001T3	TO-220FN	30	10	150	0.44	5	0.5	30
RB085T-60	TO-220FN	60	10	100	0.58	5	0.3	60
RB225T-60	TO-220FN	60	30	100	0.63	15	0.6	60
RB095T-90	TO-220FN	90	6	100	0.75	3	0.15	90
RB085T-90	TO-220FN	90	10	100	0.83	5	0.15	90
RB205T-90	TO-220FN	90	15	100	0.78	7.5	0.3	90
RB215T-90	TO-220FN	90	20	100	0.75	10	0.4	90

Optical Block

High-Brightness / High-heat radiation white LEDs Top view type

Part No.	Package	Emitting color	V _F (V)	I _F (mA)	Brightness(cd)
SMLK15WBFPW	PSML2	White	3.8	100	6
SMLK26WBGW	PSML2	White	3.2	100	7.2

High-Brightness / High-heat radiation white LEDs Side view type

Part No.	Package	Emitting color	V _F (V)	I _F (mA)	Brightness(cd)
t=2.15mm Side view type	PSML-S	White	3.8	100	6.2
t=0.8mm Side view type	PSML-ST	White	3.2	20	2

High Power LEDs

Part No.	Emitting color	Luminous Intensity(lm)	Operation Current(mA)	Color Temperature(K)
☆ 1W type	Daylight Color	100	350	12000
	Natural white Color	60		5500
	Warm white Color	50		3000
☆ 3W type	Daylight Color	200	900	12000
	Natural white Color	130		5500
	Warm white Color	100		3000
☆ 5W type	Daylight Color	300	1500	12000
	Natural white Color	210		5500
	Warm white Color	180		3000

Modules

LED Driver Modules for Illumination

Part No.	Package	Input Voltage(V)	LED Specifications	Number of LED	Output current (mA)
BP5843A	SIP11 (32.9 x 25.0 x 15.1mm)	AC100V (DC113 to 170V)	1W	1 to 3	166 to 350
BP5842A			3W	1	458 to 960
BP5844			1W	3	166 to 350
BP5845W	DIP16 (46.0 x 22.2 x 18.3mm)		1W	6 to 9	166 to 360

General-purpose products

MOSFETs

Part No.	Package	Polarity	V _{DSS} (V)	I _D (A)	P _D (W) (T _a =25°C)	R _{DS(on) Typ. (mΩ)}			Q _g (nC)	Drive Voltage (V)	
						V _{GS} =2.5V	V _{GS} =4V	V _{GS} =4.5V V _{GS} =10V			
RSS070P05	SOP8	Pch	-45	-7	2	—	28	25	19	34	4
RSS060P05	SOP8	Pch	-45	-6	2	—	38	35	26	23	4
RHU020N06	UMT3	Nch	60	0.2	0.2	—	2.8Ω	—	1.7Ω	—	4
SM6K2	SMT6	Nch+Nch	60	0.2	0.2	—	2.8Ω	—	1.7Ω	—	4

Bipolar Transistors

Part No.	Package	Polarity	V _{CEO} (V)	I _C (A)	P _C (W) (T _a =25°C)	hFE
2SA1576A	UMT3	PNP	-50	-0.15	0.2	120 to 390
2SC4081	UMT3	NPN	50	0.15	0.5	120 to 390

Digital Transistors

Part No.	Package	Polarity	V _{CC} (V)	I _O (mA)	P _D (W) (T _a =25°C)	G _I	R ₁ / R ₂ (kΩ)
DTA114EUA	UMT3	PNP	-50	-50	0.2	30 or more	10 / 10
DTA144EUA	UMT3	PNP	-50	-30	0.2	68 or more	47 / 47
DTC114EUA	UMT3	NPN	50	50	0.2	30 or more	10 / 10
DTC144EUA	UMT3	NPN	50	30	0.2	68 or more	47 / 47

☆: Under development

The content specified in this document is correct as of 1st. November, 2008.

No copying or reproduction of this document, in part or in whole, is permitted without the consent of ROHM CO.,LTD.

The content specified herein is subject to change for improvement without notice.

The content specified herein is for the purpose of introducing ROHM's products (hereinafter "Products"). If you wish to use any such Product, please be sure to refer to the specifications, which can be obtained from ROHM upon request.

Examples of application circuits, circuit constants and any other information contained herein illustrate the standard usage and operations of the Products. The peripheral conditions must be taken into account when designing circuits for mass production.

Great care was taken in ensuring the accuracy of the information specified in this document. However, should you incur any damage arising from any inaccuracy or misprint of such information, ROHM shall bear no responsibility for such damage.

The technical information specified herein is intended only to show the typical functions of and examples of application circuits for the Products. ROHM does not grant you, explicitly or implicitly, any license to use or exercise intellectual property or other rights held by ROHM and other parties. ROHM shall bear no responsibility whatsoever for any dispute arising from the use of such technical information.

The Products specified in this document are intended to be used with general-use electronic equipment or devices (such as audio visual equipment, office-automation equipment, communication devices, electronic appliances and amusement devices).

The Products are not designed to be radiation tolerant.

While ROHM always makes efforts to enhance the quality and reliability of its Products, a Product may fail or malfunction for a variety of reasons.

Please be sure to implement in your equipment using the Products safety measures to guard against the possibility of physical injury, fire or any other damage caused in the event of the failure of any Product, such as derating, redundancy, fire control and fail-safe designs. ROHM shall bear no responsibility whatsoever for your use of any Product outside of the prescribed scope or not in accordance with the instruction manual.

The Products are not designed or manufactured to be used with any equipment, device or system which requires an extremely high level of reliability the failure or malfunction of which may result in a direct threat to human life or create a risk of human injury (such as a medical instrument, transportation equipment, aerospace machinery, nuclear-reactor controller, fuel-controller or other safety device). ROHM shall bear no responsibility in any way for use of any of the Products for the above special purposes. If a Product is intended to be used for any such special purpose, please contact a ROHM sales representative before purchasing.

If you intend to export or ship overseas any Product or technology specified herein that may be controlled under the Foreign Exchange and the Foreign Trade Law, you will be required to obtain a license or permit under the Law.

ROHM Sales Offices

Contact us for further information about the products.

San Diego	+1-858-625-3630	United Kingdom	+44-1-908-272400	Tianjin	+86-22-23029181	Xiamen	+86-592-238-5705
Atlanta	+1-770-754-5972	Denmark	+45-3694-4739	Shanghai	+86-21-6279-2727	Zhuhai	+86-756-3232-480
Boston	+1-978-371-0382	Espoo	+358-9725-54491	Hangzhou	+86-571-87658072	Hong Kong	+852-2-740-6262
Chicago	+1-847-368-1006	Salto	+358-2-7332234	Nanjing	+86-25-8689-0015	Taipei	+886-2-2500-6956
Dallas	+1-972-473-3748	Oulu	+358-8-5372930	Ningbo	+86-574-87654201	Kaohsiung	+886-7-237-0881
Denver	+1-303-708-0908	Barcelona	+34-9375-24320	Qingdao	+86-532-8577-9312	Singapore	+65-6332-2322
Detroit	+1-248-348-9920	Hungary	+36-1-4719338	Suzhou	+86-512-6807-1300	Philippines	+63-2-807-6872
Nashville	+1-615-620-6700	Poland	+48-22-5757213	Wuxi	+86-510-82702693	Thailand	+66-2-254-4890
Mexico	+52-33-3123-2001	Russia	+7-495-739-41-74	Guangzhou	+86-20-3878-8100	Kuala Lumpur	+60-3-7958-8355
Düsseldorf	+49-2154-9210	Seoul	+82-2-8182-700	Huizhou	+86-752-205-1054	Penang	+60-4-2286453
Munich	+49-8999-216168	Masan	+82-55-240-6234	Fuzhou	+86-591-8801-8698	Kyoto	+81-75-365-1218
Stuttgart	+49-711-7272-370	Dalian	+86-411-8230-8549	Dongguan	+86-769-8393-3320	Yokohama	+81-45-476-2290
France	+33-1-5697-3060	Beijing	+86-10-8525-2483	Shenzhen	+86-755-8307-3008		

Catalog No.51Q6013E 1.2009 ROHM © 3000 NZ

R0128A

ROHM Co.,Ltd.

21 Saiin Mizosaki-cho, Ukyo-ku,
Kyoto 615-8585 Japan
TEL : +81-75-311-2121 FAX : +81-75-315-0172

www.rohm.com

ROHM
SEMICONDUCTOR